

**Life cycle assessment of
offshore and onshore sited
wind power plants based on
Vestas V90-3.0 MW
turbines**



Vestas

This report was published by Vestas Wind Systems A/S in March 2005. The current version is the second edition published July in 2006. The changes made in this version do not affect the overall conclusions made in the first version. However the significant corrections have been incorporated in the second version:

- Processes for manufacturing of several types of plastic have been corrected.
- Process for manufacturing of steel plates has been corrected.

By correcting these processes correction of the total life cycle assessment (LCA), has been necessary. Significant corrections of environmental aspects are:

- Total water consumption of onshore and offshore turbines has been reduced by 76% and 65% respectively.
- For water emission “Chemical oxygen demand (COD)” values of onshore and offshore turbines has increased by 395% and 96% respectively.
- “Ozone depletion” values of onshore and offshore turbines have increased by 414% and 35% respectively.
- “Human tox” and “Eco tox” values of onshore and offshore turbines have been reduced from 0% to 96 %.
- “Hazardous waste” values of onshore and offshore turbines have been reduced by 14% and 16% respectively.
- “Slags and ashes” values of onshore and offshore turbines have increased by 10% and 6% respectively.

Changes in “hazardous waste” and “slags and ashes” are caused by the correction of the process for manufacturing of steel plates. In the process oven slag was wrongly classified as hazardous waste and not as slag and ashes as described in the chapter “manufacturing of turbines”.

Changes in water consumption are caused by the correction of processes for manufacturing several types of plastic. Water for cooling was wrongly included, now only process water is included. Furthermore a factor error was found in one of the manufacturing processes for a plastic.

The other changes are caused by the correction of processes for manufacturing several types of plastic. The significant changes of “COD” and “ozone depletion” can be explained by the fact that not many processes in this LCA besides manufacturing of plastic are linked to these environmental impacts.

The LCA model for the onshore model of the V90-3.0 MW includes a cable structure and foundation structure that is not as resource demanding as for the offshore V90-3.0 MW. That is why the same changes are more significant for the onshore turbine.

Contents:

Summary	5
Introduction	7
Goal.....	7
Objective.....	8
Target group.....	8
Method.....	8
Scope	9
Functional unit	9
Data quality requirements	9
System expansion.....	9
Lifetime.....	10
Life cycle stages	10
Offshore wind power plant	11
Electric power generation	11
Operation.....	12
Transport during operation	13
LCA project model.....	13
Onshore wind power plant	14
Electric power generation	14
Operation.....	14
Transport during operation	15
LCA project model.....	15
Data collection	15
Procedures for data collection	16
End of life scenario.....	17
Allocations.....	18
Manufacturing of turbines.....	18
Manufacturing of onshore foundation	23
Manufacturing of offshore foundation.....	23
Manufacturing of internal cables to offshore wind power plant.....	24
Manufacturing of transformer station to offshore wind power plant	24
Manufacturing of 150 kV PEX submarine-/onshore cable and SF6-system for offshore wind power plant.....	25
Resource consumption for wind power plants	26
Life cycle impact assessment	27
Environmental impacts	27
Calculation method	28
Results	29
Resource consumption per kWh produced.....	29

Energy consumption per kWh produced.....	30
Emissions to air and water per kWh produced.....	31
Environmental impacts of 1 kWh.....	32
Environmental impacts divided into life cycle stages.....	33
Comparison with European electricity.....	34
Energy balance	35
Interpretation of results	36
<i>Sensitivity analysis</i>.....	37
Energy production.....	38
Data for processing materials	38
Location	40
Lifetime.....	42
Recycling.....	43
<i>Shortcomings</i>.....	45
<i>Conclusions</i>.....	46
<i>Appendix 1</i>.....	47
<i>Appendix 2</i>.....	48
<i>Review comments</i>	48
Goal.....	50
Goal.....	50
Use	50
Target group.....	50
Scope.....	51
Functional unit	51
System boundaries.....	51
Included data categories and impacts	51
Data quality requirements.....	51
System expansion and allocation.....	52
Chosen methodology.....	52
Description of the critical review process	52
Inventory	53
Description of data	53
Verification of data.....	53
Use of data compared to the goal	54
Aggregation of data	54
Documentation of system boundaries, system expansions and allocation	54
Interpretation and limitations of selected system boundaries	54
Evaluation.....	56
Evaluation of characterization and characterization factors.....	56
Evaluation of normalization.....	56
Interpretation of results	57
Impact categories and sources.....	57
Completeness, sensitivity and consistency.....	57
Evaluation of limitations in the conclusion.....	57
Compliance with ISO 14040:1997 – ISO 14043:1997	58
<i>Conclusion</i>.....	59

Summary

This report makes up the final reporting on the life cycle assessment (LCA) of offshore and onshore sited wind power plants based on the Vestas V90-3.0 MW turbine. The LCA and the reporting have been prepared by Vestas Wind Systems A/S.

The purpose of the project is to carry out a life cycle assessment of an offshore and onshore wind power plant, respectively, as a basis for assessment of environmental improvement possibilities for wind power plants through their life cycles. Furthermore, Vestas Wind Systems A/S wishes to document the environmental performance of its wind turbines to supply customers, NGOs (non-governmental organisations), governments and other stakeholders with objective information on wind energy delivered by Vestas turbines.

Previously, similar LCA reports have been prepared for the V80-2.0 MW turbine in cooperation with Elsam Engineering A/S. This report is the first report prepared solely by Vestas Wind Systems A/S. However, data from the previous reports has been used where appropriate in the LCA of the V90-3.0 MW turbine. It has been a goal for this LCA project to improve the LCA model used in relation to the previous LCA models. The LCA has been submitted to an external expert review by Force Technology to ensure the quality of the LCA. The review by Force Technology can be seen in appendix 2.

The results of the LCA shows an improvement of the energy pay back time and of the environmental performance of the V90-3.0 MW wind turbines compared to V80-2.0 MW, as the energy balance is improved from 9.0 months for a V80-2.0 offshore to 6.8 months for a V90-3.0 MW offshore. It should be stressed that the improvement is documented by this LCA even though some important data gaps have been closed in the modelling for the V90-3.0 MW compared to the V80-2.0 MW turbine. This means that the actual environmental performance and energy pay back time has been improved even more than the results reflect.

Electricity generated from Vestas turbines results in considerably less environmental burdens compared with European average electricity, which is in accordance with common understanding.

Wind turbines generate sustainable energy, and hence no CO₂ is emitted during the production of electricity. However, seen from a life cycle perspective CO₂ is emitted during the various processes in the life cycle of a wind turbine. The LCA shows that 1 kWh electricity generated by a V90-3.0 MW offshore turbine has an impact of 5.23 grams of CO₂ during the life cycle. For an onshore V90-3.0 MW the corresponding figure is 4.64 grams of CO₂. If this is compared to the CO₂ emission of 548 grams per kWh from European average electricity it is clear that the environmental burdens are significantly lower for electricity generated by wind turbines.

The life cycle assessment shows that environmental impacts per kWh electricity generated by the offshore and onshore wind power plants are close to being identical within the expected uncertainties of the results. Resource consumption by the offshore wind power plant is significantly higher than for the onshore wind power plant. However, increased electricity generation by the offshore wind turbines outweighs the increased resource consumption.

Conclusion of Critical Review



FORCE Technology has conducted a critical review of the LCA model and the documentation and a number of random checks have been made. The review has not found anything, which in overall terms can influence the final result of the assessment. The LCA model is significantly improved and enhanced compared with the previous LCA on V80-2.0 MW. Furthermore, areas have been proposed where model and underlying data can be improved for the next LCA project. The review report can be seen in appendix 2.

Jeppe Frydendal

Head of LCA Center Denmark

M.Sc. in Engineering

FORCE Technology, Sustainability Management

Introduction

The present report makes up the final reporting on the LCA of offshore and onshore sited wind power plants based on the Vestas V90-3.0 MW turbine. Vestas Wind Systems A/S (hereafter called Vestas) has prepared the report and the underlying LCA model.

In the year 2001 Vestas and Elsam Engineering A/S completed a design scheme, in which a life cycle assessment was prepared for a Vestas V80-2.0 MW turbine^{i & ii} (*see references in last page*). In 2004 Vestas and Elsam Engineering A/S furthermore completed a life cycle assessment in which the offshore and onshore version of the V80-2.0 turbine was compared. Energy balances for the two versions were also presented in the assessments. This report is the first report prepared solely by Vestas Wind Systems A/S. The two LCAs of the V80-2.0 turbine have been used as basis for this LCA.

LCA is a method used to assess environmental aspects and potential impacts of a product. LCA is a tool that is used to present a technical estimate of the environmental consequences of products and activities. LCA does not include financial and social factors, which means that the results of an LCA cannot exclusively form the basis for assessment of a product's sustainability.

It also means that an LCA does not give detailed, scientific and final answers as to the environmental properties of a product, as an LCA does not take into account all the impacts on surroundings caused by a product in connection with use (e.g. noise, impact on fauna, etc.) To obtain a more complete environmental description, LCA must be combined with other environmental assessments as for instance environmental consequence assessments (e.g. Assessment of Impact of the Environment, AIE), risk assessment and environmental management.

LCA is a valuable tool to provide an understanding of environmental properties of a product and in many cases it can be used internally in companies as a tool in product development.

Some of the most essential limitations of LCA are:

- Many selections and assumptions must to be made (e.g. selection of system boundaries and data sources), which might be subjective.
- The accuracy of an LCA will depend on the access to or the existence of relevant and liable data.
- Models used for mapping or assessing environmental impacts are restrained by their conditions and will not necessarily be accessible for all potential impact categories or applications.

Goal

The goal of the LCA of the V90-3 MW turbine has partly been to use life cycle assessments for environmental improvement strategies in connection with product development and partly to use LCA data to document the environmental performance of the V90-3.0 MW turbine. This should be done in form of the present report but also for the preparation of an environmental declaration for electricity produced by the V90-3.0 MW turbine. Furthermore, it has been a goal to improve the existing LCA model for Vestas wind turbines.

Objective

The objective has been to prepare an LCA of an offshore and onshore sited wind power plant based on the V90-3.0 MW Vestas turbine, respectively, including the connection of the wind power plant to the existing electricity grid. Results from this work will be used when considering improvement strategies for technology and product development at Vestas, and when preparing an environmental product declaration (EPD) of the two turbine types and of electricity generated by these.

Target group

This LCA is directed primarily to four target groups:

- Customers of Vestas
- Vestas Wind Systems A/S
- Investors of Vestas Wind Systems A/S
- Other stakeholders, including energy authorities from countries with interest in renewable energy that should be able to use the overall results as part of an assessment of the environmental characteristics of Vestas turbines.

Method

This LCA has been prepared according to the principles of ISO 14040-14043 with the exception that a review by interested parties has not been carried out as required when comparative assertions are made. This LCA has furthermore been submitted to an external expert review at Force Technology.

ISO 14040 deals with “Principles and framework” and determines the overall frames, principles and requirements for preparing and reporting of LCAs.

ISO 14041 “Goal and scope definition and inventory analysis” together with ISO 14040 determine the requirements and procedures necessary for the data collection and improvements of objectives and delimitation of an LCA. It also determines the establishment, interpretation and reporting of the mapping of a lifecycle.

ISO 14042 “Life cycle impact assessment” specifies requirements for the execution of the assessment of environmental impacts in the life cycle and relation between this and the other steps in the LCA.

ISO 14043 “Life cycle interpretation” determines requirements to and recommendation of the interpretation of results of a life cycle assessment or life cycle mapping.

For modelling, the PC tool GaBi is used based on the EDIP methodology^{ix}. EDIP is an abbreviation for environmental design of industrial products.

Scope

The selected turbine type is a Vestas V90-3.0 MW turbine. In this LCA, however, both an onshore and offshore sited wind power plant is dealt with. Data regarding wind power plant configuration and production for both wind power plants has been derived, not from actual sites, but from general project models used at Vestas.

Regarding offshore and onshore turbines the most essential difference is the tower height. However, there are also minor differences in the nacelle. The foundations are not produced by Vestas. The foundations for onshore and offshore sited wind power plants differ considerably, see more detailed descriptions in chapters “Offshore wind power plant” and “Onshore wind power plant”.

Main data for a V90-3.0 MW turbine can be seen in table 1.

	Offshore turbine 80m hub height on monopile foundation	Onshore turbine 105m hub height on concrete foundation
Tower	156 tons	235 tons
Nacelle	68 tons	68 tons
Rotor	40 tons	40 tons
Foundation	203 tons	1,200 tons

Table 1: Main data for turbines for offshore and onshore sited wind power plants.

Functional unit

The functional unit is selected as 1 kWh electricity generated at the wind power plants with the selected turbines. Therefore, all the impacts are estimated for this functional unit, which makes the results comparable with results from LCAs from other electricity production technologies.

Note that this functional unit only includes electricity delivered to the electricity grid and not electricity delivered to the consumer.

Data quality requirements

Data in this study shall as far as possible be specific data from Vestas and suppliers of Vestas. This data should preferably be in form of technical specifications, and if this is not possible in the form of statements from experts. For raw materials, however, generic data from LCA databases such as the GaBi EDIP database is preferred.

The data used shall be for present technologies and should reflect processes in the industrialised parts of the world. This is also valid for the disposal stage even though this will take place in the future.

For the generic data from LCA databases the best available processes regarding time coverage and suitability shall be used.

System expansion

When materials are recycled, resources, waste and emissions for the recycling process have been included in the model. Furthermore, recovered materials are included and modelled as avoided production, which means that the model is credited.

Lifetime

It is assumed that the lifetime of the wind power plant turbines and internal cables is 20 years. Still, it is expected that the operation of the turbines will exceed 20 years, but there is no certainty for this. This corresponds with the design life time of the V90-3.0 MW.

Life cycle stages

The assessment includes production, transport, erection, operation, dismantling and removal of turbines, foundations and transmission grid to the existing electricity grid. This is illustrated by the following figure with an attendant explanation of the specific life stages.

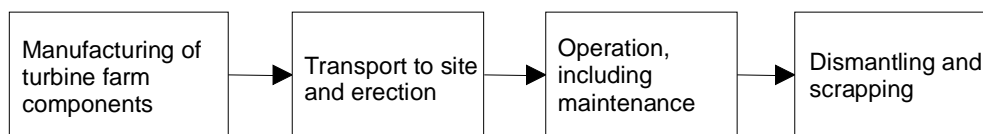

Figure 1: Life cycle stages.

Manufacturing of turbine farm components includes manufacturing of foundations, towers, nacelles and blades for offshore and onshore turbines and manufacturing of parts of the transmission grid.

Transport to site and erection includes transport by truck (+ escorting car(s), in case this is found necessary) and transport by vessel at sea. Furthermore, transport of certain large components from sub-suppliers to Vestas is included in the project model.

Erection includes crange and other construction work at site.

Operation, including maintenance includes change of oil, lubrication and transport to and from the turbines is included in the stages of operation and maintenance. Furthermore, renovation of gearbox and generator is included. Transport onshore is carried out by truck, while at sea vessel and helicopter are used.

Dismantling and scrapping includes crange when dismantling, transport from erection place to the final disposal (by vessel at sea and onshore by truck + escorting car(s), if necessary). Furthermore, the removal of materials is included, either by recycling or by deposit.

When recycling this is modelled with a system expansion where recycling processes are included and the materials made ready for reuse is included as avoided production. This means for instance that energy for shredding and a certain loss to waste are included.

A more detailed description of the wind power plants and the included materials will appear from the following chapters.

Offshore wind power plant

The offshore wind power plant in this LCA study is based on a general project model used for financial calculations at Vestas, and expresses a realistic site placement offshore.

The offshore wind power plant is placed approximately 14 km from the coast and consists of 100 Vestas V90-3.0 MW turbines, erected on monopiles on a water depth between 6.5 and 13.5 metres at mean sea level. It is assumed that part of the monopile, which is below the sea bed, will be cut off and left in the sea bed. The rest of the monopile will be recycled.

The diameter of the foundations is approximately 4 metres. The foundations are rammed down approximately 25m into the sea bed. Between foundation and tower there is a transition piece widening the diameter of the foundation to the tower. A boat platform is mounted on every transition piece. This platform is used when the turbines are visited by boat.

The turbines are mutually connected by a 32 kV cable grid, which is assembled on the transformer station. At the transformer station, the produced electricity from the wind power plant is gathered and carried on to the shore. The transformer station is placed offshore close to the wind turbines and consists of transformer, foundation, platform and internal cables.

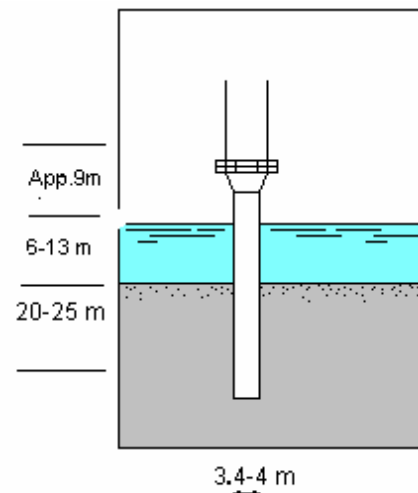

Figure 2: Monopile foundation

The foundation of the transformer platform consists of three piles; two of these have a diameter of about 1.6m and one has a diameter of 2.3m. The three foundation piles are mutually combined by lattice girders. The transformer station has a life time of 40 years, as it is assumed that the wind power plant will be replaced by a new one using the same transformer station.

Electric power generation

Electric power generation from the wind power plant is stated to 1,423 GWh/year, i.e. each turbine produces 14,230 MWh/year corresponding to a capacity factor of 54.16 (the capacity factor expresses the efficiency of the electricity generation in relation to a theoretical maximum electricity generation). These figures originate from recognised calculations of electric power generation and express actual data from the established wind power plant at Horns Reef in Denmark, which has an attractive placement regarding electricity generation.

This figure indicates the wind power plant's production of electricity to be delivered to the transformer stations, including the grid loss in the internal cables of the farm. However, from the transformer station until the connection to the existing transformer onshore, there is an estimated grid loss in the transformer and the cables of 22 GWh/year for the wind power plant. Approximately 10% of this loss comes from the transformerⁱⁱⁱ.

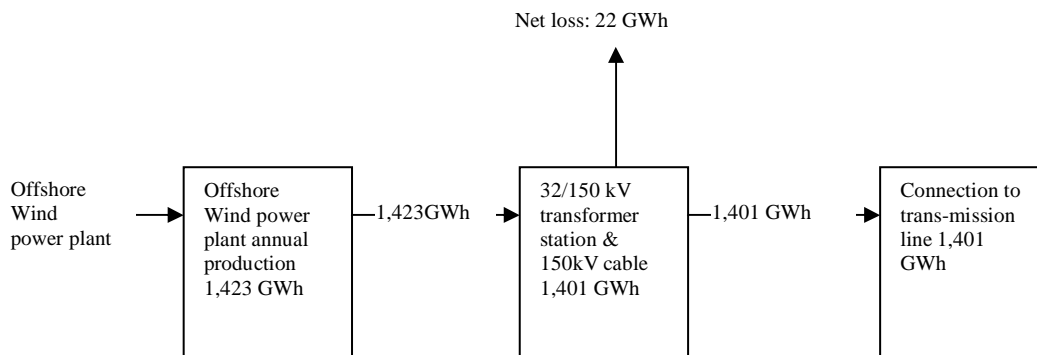

Figure 3: Creation of system for LCA project model for offshore wind power plant

Operation

In connection with the operation of turbines, wear and tear will take place especially of rotating parts.

The turbines are dimensioned and constructed to a lifetime of minimum 20 years. To be on the safe side in this LCA, a conservative estimate of maintenance of the turbines is assumed. It is expected that during the lifetime of 20 years one reconditioning/renewal of half of either the gearboxes or the generators must be carried out which, as a minimum, is expected to comprise renewal of the bearings. To simplify the model of operation, only the gearboxes have been included in the model, but in return the project model comprises a total renewal of half of the gearboxes once in the turbine's lifetime. Thus, the model should now include an abundant amount of materials, as several of the gearboxes and the generators will probably be repaired and not renewed. Moreover, the gearbox is significantly heavier than the generator.

In addition, materials for servicing of the turbines are included, i.e. change of oil and lubrication of gearbox, generator, etc.

The foundations of the offshore turbines are given cathodic protection as corrosion prevention, i.e. an active anode is used, in this case aluminium. This protection implies that aluminium is consumed through the lifetime.

Paint repair and renewal of active anodes to cathodic protection must be carried out at the transformer station after an operation time of 10-15 years. Paint repair is not included as this is expected to be insignificant.

Transport during operation

It is estimated that inspection will be carried out four times a year per turbine. Three of these are assumed to be carried out by helicopter and the remaining one by boat. Inspection will also include about 2,400 km a year by car per turbine. Since no data for a helicopter is available, recalculated emission data from a mid-sized jet is used.

Regular inspection of the cables at the offshore farm is not included in this study and is expected to be insignificant.

LCA project model

The project model includes the turbines, internal cables, offshore transformer station, sea cable, cable transmission station onshore and onshore cable to the existing grid. Each of these includes materials, manufacturing, transport, erection, operation, dismantling and scrapping. Figure 4 shows the elements included in the LCA project model for the offshore wind power plant.

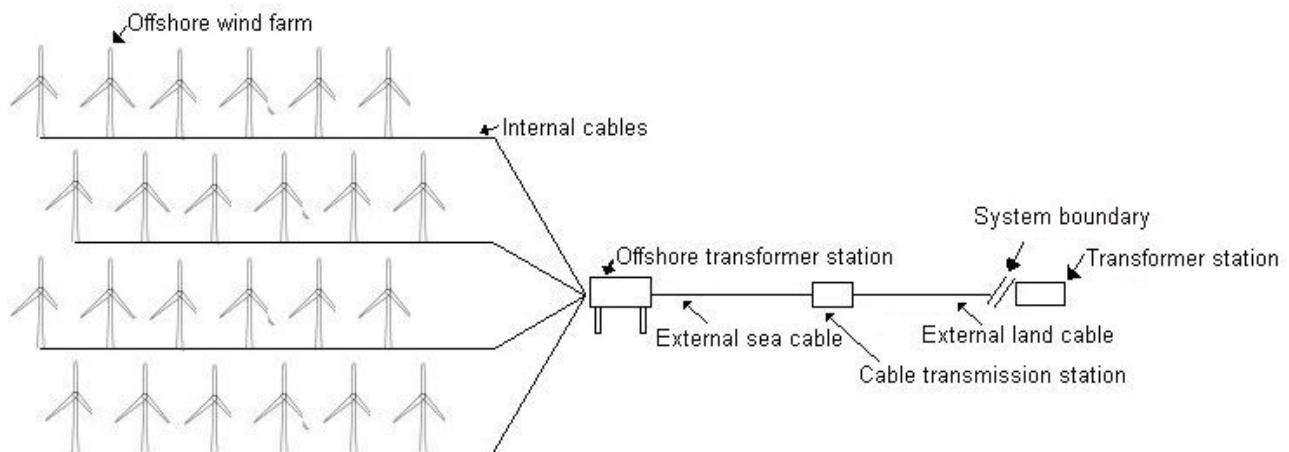

Figure 4: Sketch of offshore wind power plant structure with system boundary for the LCA.

Onshore wind power plant

The onshore wind power plant in this LCA study is based on general project models used at Vestas.

The onshore wind power plant consists of 100 Vestas V90-3.0 MW turbines, erected on gravitation foundations.

All the turbines are connected to the existing distribution grid in a 10/60 kV transformer station. The cables connecting the turbines internally and to the transformer station are 10 kV cables. All cable extensions are placed in the soil.

See figure 6 for a principle sketch of the onshore wind power plant.

At the onshore wind power plant, there is a total of 140 km of 10 kV cables for connecting all 100 turbines to an existing transformer station.

The turbines are erected on concrete foundations. Each turbine foundation is established in connection to a road, working and turning area. Road, working area and turning area are not included in this study and are expected to be insignificant.

The size of the foundations is dependent on geotechnical conditions. Normally, traditional bottom plates are approximately 15×15 m wide and 2 m deep. In total, approximately 475m^3 of reinforced concrete.

The below figure shows a principle design of an onshore foundation

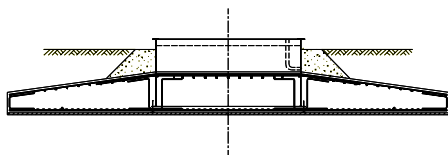

Figure 5: Principle sketch foundation for onshore turbines.

Electric power generation

The electric power generation from the wind power plant is stated to 789 GWh/year, i.e. each turbine produces 7,890 MWh/year, corresponding to a capacity factor of 30.02. These figures originate from recognised calculations of electric power generation and express a realistic site placement in for example Denmark.

Losses in the cables are not calculated, as the loss is considered insignificant as the cables are very short.

Operation

In connection with the operation of turbines, wear and tear will take place especially of rotating parts.

The turbines are dimensioned and constructed to a lifetime of minimum 20 years. To be on the safe side in this LCA, a conservative estimate of maintenance of the turbines is assumed. It is expected

that during the lifetime of 20 years one reconditioning/renewal of half of either the gearboxes or the generators must be carried out which, as a minimum, is expected to comprise renewal of the bearings. To simplify the model of operation, only the gearboxes have been included in the model, but in return the project model comprises a total renewal of half of the gearboxes once in the turbine's lifetime. Thus, the model should now include an abundant amount of materials, as several of the gearboxes and the generators will probably be repaired and not renewed. Moreover, the gearbox is significantly heavier than the generator.

In addition, materials for servicing of the turbines are included, i.e. change of oil and lubrication of gearbox, generator, etc.

Transport during operation

Twice a year, a technician must carry out inspection of turbines and cables. Therefore, transport of 900 km a year by car per turbine has been included in the project model.

LCA project model

The project model includes the turbines, internal cables, offshore transformer station, sea cable, cable transmission station onshore and onshore cable to the existing grid. Each of these includes materials, manufacturing, transport, erection, operation, dismantling and scrapping. Figure 4 shows the elements included in the LCA project model for the offshore wind power plant.

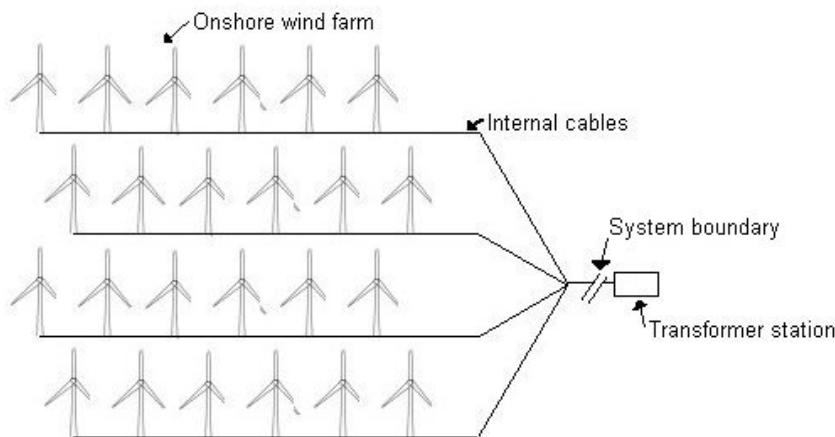

Figure 6: Grid connection system for onshore wind power plant and system boundary of the LCA.

Data collection

The collection of data has taken place in close co-operation with relevant functions at Vestas and technical specifications of the V90-3.0 MW turbine have been used. All assumptions of and approaches to materials and processes, which are new in relation to the previous LCA reports ^{i & ii}, have been evaluated and discussed.

As regards the transmission part to the offshore wind power plant, data from the previous LCA reports ^{i & ii} has been used.

Concerning the turbines, the most significant environmental impacts will most typically arise during manufacturing of the turbines and final disposal of the turbines. On the other hand, the operational stage does not contribute significantly to environmental impacts. Therefore, data collection has been focused on procuring as precise data as possible for the production and disposal stages. The turbine system is divided into the following component systems:

- tower
- nacelle
- blades
- foundation
- cables – connecting the individual wind turbines and connecting the wind power plant to the existing grid (for offshore this includes structures for onshore bringing of the electricity connection)
- Offshore transformer station (only for offshore wind power plant)

In relation to data collection, the target for including materials has been to cover 100% of the turbine's weight, as it has previously been proven that manufacturing of the turbine causes the major part of environmental impacts in the whole life cycle of the turbine^{i & ii}. The same target has been used in connection with data for the other parts of the farm.

In connection with LCA data for the used materials, it has been attempted to cover 95% of what regards all first level materials (i.e. materials used on Vestas factories, e.g. Prepreg for blades and steel for towers). As regards second level processes (i.e. resources, materials and consumables used by sub-suppliers, e.g. energy used in the manufacture of steel profiles and content of substances in Prepreg) it has been a question of prioritising the selection of materials of which it has been important to collect information. To assess the significance, not including data, a sensitivity analysis has been performed. The sensitivity analysis can be seen in the chapter "Sensitivity analysis".

Since the last LCA project, Vestas has insourced facilities for producing cast iron components and for metallizing and painting of towers. Data from these facilities has been used in the current LCA.

Since Vestas sources components from different suppliers and also has production facilities all over the world a general process for electricity supply has been chosen (European electricity, 1990).

During the modelling it has been discovered that data regarding radioactive waste was too high in relation to the normalisation reference of the used EDIP methodology. Waste flows regarding radioactive waste have instead been scaled on the basis of an environmental product declaration for Nuclear power^{iv}.

Procedures for data collection

Data collection for the turbines has mainly been carried out on the basis of the item lists for the two turbine types and technical drawings and specifications of various components. The item lists are taken from Vestas' ERP system, which furthermore contains information about material type and weight of a very large part of incoming raw materials and semi-manufactured articles. As a starting

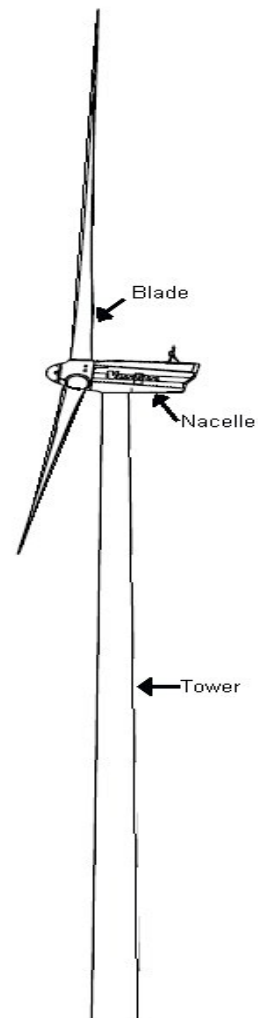

Figure 7, Sketch of V90-3.0 MW turbine

point, all the item numbers on the item lists are included. As regards the items, where the information has not been immediately accessible it has been assessed in each case whether it would be relevant to search for further information about weight and material composition. This has resulted in an up scaling of some components by weight from the previous LCA of the V80-2.0 MWⁱⁱ. Although there are technological differences between the V80-2.0 MW and the V90-3.0 MW turbine, the materials and processes used in the life cycle does not differ significantly. As regards large items as e.g. transformer and generator, the information originates from the supplier.

Information about overall conditions for the wind power plants, transmission, foundations, electric power generation and for some part operation and maintenance is collected from relevant departments in Vestas.

Where possible, the information about various materials is taken from the LCA tool GaBi, which has been used through Vestas' work with LCAs during recent years. In cases where LCA data was not available or the existing data was inadequate, new data has been collected through suppliers, the Internet and other LCA studies. In some cases, it has been necessary to make assumptions about the materials. These assumptions are described in the individual sections below. Since only the material input could be collected for some components, general processing data for steel, glass fibre, rubber and plastics have been used. Steel covers the majority of the material consumption.

End of life scenario

As regards the end of life scenario, the scenario used in the previous LCA reportⁱⁱ has been used in this study as well. The scenario is based on a workshop where the dismantling of the turbines and removal of components/materials were discussed. Participants at the workshop were companies and institutions working with dismantling, scrapping and recycling. The following parties were represented:

- Vestas
- Elsam Engineering A/S
- H.J. Hansen Genvindingsindustri A/S (working with dismantling, recovery and electronic waste)
- Demex (working with dismantling)
- Waste Centre Denmark
- RISØ, who at that time was working on an assessment of future wind turbines in a life cycle perspective

Furthermore, input from H.J. Hansen about recent work with the recovery of turbine blades is used in this scenario.

The following removal scenario is used in this study:

Material	Scenario
Steel	100% recycling, (90% recovery and 10% landfilling)
Cast iron	100% recycling, (90% recovery and 10% landfilling)
Stainless steel	100% recycling, (90% recovery and 10% landfilling)
High-strength steel	100% recycling, (90% recovery and 10% landfilling)
Copper	100% recycling, (90% recovery and 10% landfilling)
Aluminium	100% recycling, (90% recovery and 10% landfilling)
Lead	100% recycling, (90% recovery and 10% landfilling)
Glass fibre components	100% incineration of composite material with heat recovery, glass content is hereafter landfilled
PVC-plastic	Deposit of fractions that can be disassembled, incineration of the rest.
Other plastic	100% incineration of waste with heat recovery
Rubber	100% incineration of waste with heat recovery

Table 2: Removal scenario for materials

The above-mentioned scenarios of data regarding disposal derive from literature data and from the recycling workshop. However, some of the experts from the recycling industry expressed that the loss of recovering steel and metal is less than the 10%, which is used in this study for all metals as presented in the table above. The 10% is maintained as there is much uncertainty about the figure and at the same time it is not known exactly if all materials can be disassembled totally in material fractions, i.e. there might be a loss, before the recycling process is started.

Data for processing of metal scrap into metal that can be used in the production of new components is furthermore included.

Allocations

As turbines only produce electricity and e.g. no heat, there is no need to allocate between more products. This simplifies the inventory.

Manufacturing of turbines

Vestas' energy consumption and waste production

Vestas' energy consumption and waste production for manufacturing of turbines is reported in the Environmental Statement for 2003 and indicates the total energy consumption and waste production in Vestas' factories and offices covered by Vestas' environmental statement. Energy consumption is stated as a key figure related to the energy, which may be produced through the lifetime of the turbine (20 years), on all turbines manufactured at Vestas in 2003.

Consumption includes electricity, heat, oil, gas and water. Waste production includes waste and wastewater. The distribution between these various energy forms is found in the Environmental Statement for 2003. Consumption covers the total consumption by all buildings and processes. It has not been possible to divide energy consumption among the individual turbine components. However,

it is included as a total amount for the manufacture of one turbine.

A percentage of the electricity used by Vestas is CO₂ neutral. This is because Vestas has entered into a purchase agreement concerning CO₂ neutral electricity. Furthermore, Vestas owns wind turbines which produce CO₂ neutral electricity. In 2003, 69% of the total electricity consumption was from CO₂-neutral energy sources.

Energy system	Share	Modelled as
- hydro power	54%	Norwegian electricity 1990 (99.7% hydro power + 0.4% conventional power plants)
- wind power	14%	Electricity from turbines (results from scheme design, PSO 1999)
-Other CO ₂ neutral	1%	Norwegian electricity 1990 (99.7% hydro power + 0.4% conventional power plants)
- Other electricity	31%	Electricity, EU 1990

Table 3: Vestas' electricity consumption 2003.

Manufacturing of tower

Towers for Vestas' turbines are to some extent manufactured at Vestas' own factories, and the rest is purchased from sub-suppliers. In this project, data from towers manufactured by Vestas has been used, including resource consumption, emissions and waste generated.

Towers are manufactured of steel. The steel is delivered to Vestas in steel plates, which have already been pre-cut in a way that Vestas' factories do not need to cut up the plates any further. Data for standard steel plates from the EDIP database have been used in this study. For pre-cutting resources and emissions equivalent to "production of steel profiles" have been used. Cut-off waste is recycled and modelled as such. When the steel plates arrive at Vestas, the plates for the tower sections are rolled. Every section is welded lengthwise after which the individual sections are welded together. Subsequent treatment, i.e. sandblasting and surface treatment of towers is dependent on the manufacturing site either performed at Vestas or at sub-suppliers.

In this project, manufacturing and the subsequent surface treatment have been included.

The manufacturing of steel plates has been modelled as steel plates from the EDIP database, yet in a slightly modified version based on information from the Danish Steel Rolling Mill, which has also been used in the scheme design.

The process, which has been found in the EDIP database for steel plates (89% primary), has been found not to be up to date and not to dispose of waste correctly. Oven slag is produced when manufacturing steel, and in the EDIP process oven slag has been defined as hazardous waste. Actually, oven slag is reused in the asphaltⁱⁱ industry and oven slag has not been defined as hazardous waste in accordance with the Danish Ministry of The Environment's Statutory Order (Ann. No. 619 of 27/06/2000). Therefore, a modified version of the steel process has been made, in which oven slag has been defined as bulk waste instead of hazardous waste. A form of reusing oven slag should have been included, but to simplify the data collection it has been included as bulk waste.

Data regarding consumption of steel, welding wire, welding powder, paint, metallizing agent, and grit for shot blasting originates from Vestas' item lists and information from the sub-suppliers.

Manufacturing of nacelle

The nacelle consists of the nacelle cover, generator, gear, transformer, etc.

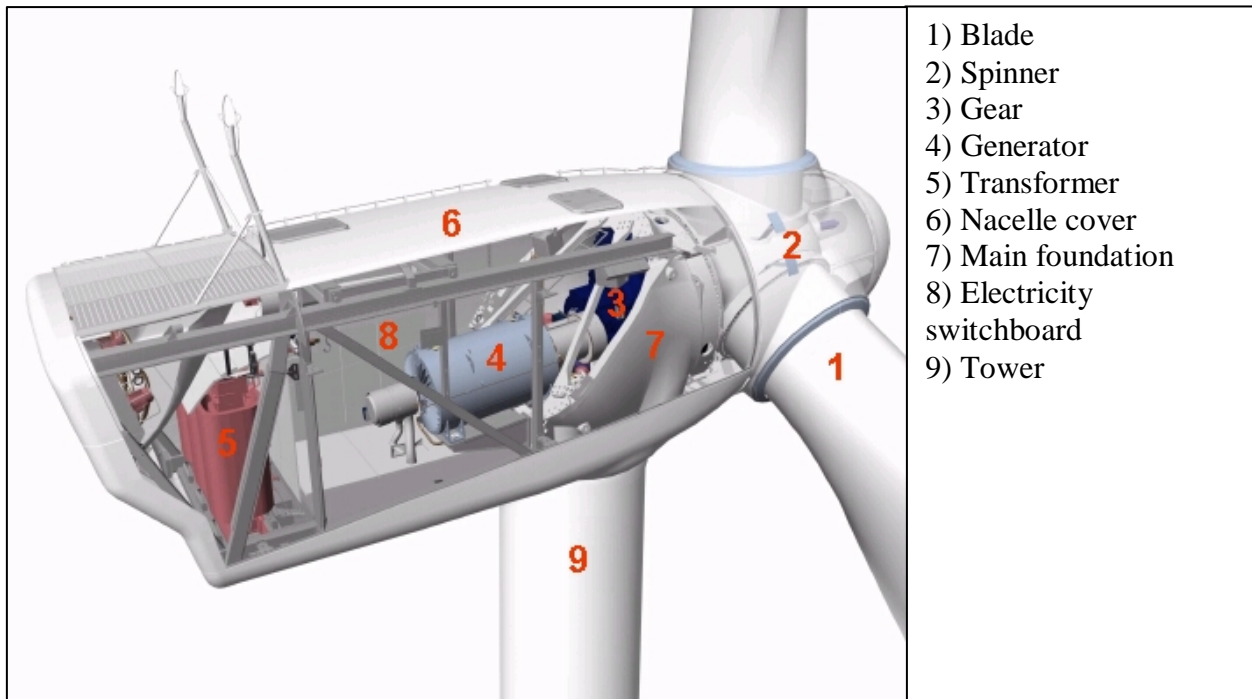

Figure 8: Components in V90-3.0 MW nacelle.

Some of the individual components are not manufactured by Vestas, but are purchased from sub-suppliers. Final finishing (welding, metal cutting) and subsequent assembly takes place at Vestas' factories. The following description lists data on the most significant components:

Gear

Data for the V90-3.0 MW gearbox is based on the V80-2.0 MW gearbox ⁱⁱ and is scaled by weight.

Generator

According to the supplier, the generator mainly consists of steel and copper.

The manufacturer has informed of materials used, energy consumption used during the manufacturing process as well as waste generated.

Transformer

Raw materials used for the transformer is based on the previous LCA of V80-2.0 MW ⁱⁱ, and scaled on the basis of the weight for the transformer to the V90-3.0 MW.

The supplier has informed of energy consumption used during the manufacturing process, as well as waste generated.

Nacelle cover

The nacelle cover for a 3.0 MW wind turbine is manufactured of composite material. The Danish plastic industry has made an LCA screening of various plastic materials, including the manufacturing

of nacelle covers ^v. Information from this has been used in present LCA. Results from the LCA on the V80-2.0 MW ⁱⁱ have been scaled according to weight.

Electricity switchboard

The control system, which is located in the nacelle, consists of electricity switchboards. Results from the LCA on the V80-2.0 MW ⁱⁱ has been scaled up with the weight of the switchboard. The content of the electronics are based on a model from a report from the Danish Environmental Protection Agency ^{vi}.

Main foundation

The main foundation is made of cast iron and produced at Vestas' casting facilities (Windcast). General data has been delivered from Windcast on cast iron production, scaled according to weight.

Other parts in the nacelle

In addition to the above-mentioned components the nacelle also consists of a range of other components as i.e.:

- Yaw system
- Hydraulic systems
- Cables.

All parts mentioned above are also represented in this LCA, as we have used data about the individual part's weight and materials and data for processing of steel, glass fibre, rubber and plastics.

Manufacturing of rotor

The blades are produced at Vestas' blades factories.

Vestas mainly uses Prepreg for the V90 blade. Prepreg is a glass fibre mat impregnated with epoxy resin. It has been difficult to obtain information from the manufacturer and supplier about the composition and the manufacturing of Prepreg.

Based on the material safety data sheets from the supplier it is assumed that Prepreg consists of approximately 40% epoxy and 60% glass fibre. Data on glass fibre found in the EDIP database and data collected in the previous LCAⁱ is used for epoxy.

The blades are primarily manufactured of Prepreg, which is cured by using heat and vacuum. A blade is constructed over a spar/root joint, which is made of Prepreg. The blade consists of two blade shelves glued on a spar. The strength of the blade lies in the spar.

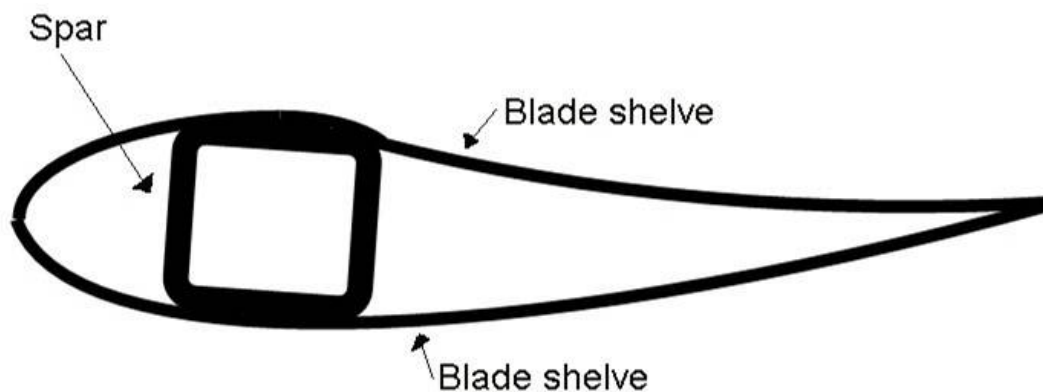

Figure 9: Rough sketch of a cross-section of a blade

Prepreg is delivered to Vestas in rolls. The Prepreg rolls are covered with separation film. At Vestas, Prepreg is cut into appropriate pieces to the spar and the blade shell.

Aside from Prepreg, carbon fibres are used in the V90 blade. Data on carbon fibres have been found in the GaBi database. The content of carbon fibre in composite products has been found in Vestas' product specifications.

Polyurethane (PUR) glue and other materials are used to assemble blade shells and spars. Average data on glue has been used in this case.

The spinner is also a part of the rotor. Finished part components for the spinner are delivered to the Vestas sites where assembly is carried out. The spinner consists of nose cone supports, blade hub, torque arm plates, torque arm shafts and torque arm blocks. Furthermore, the spinner is constructed of fibre glass-reinforced polyester. Information about all components, material types and weights of these has been found in technical specifications. The fibre glass-reinforced polyester has been modelled as described in the 'Nacelle Cover' section.

Apart from the above-mentioned materials auxiliary materials such as vacuum fleece and various plastic films are used in the production of the blades. These materials are included in this study.

Waste from the blade manufacturing process

When using Prepreg in the manufacturing process up to 10% of the Prepreg turns into waste due to cut-offs. A large percentage of this waste is sent to recycling as it is directly used in the production of e.g. high-strength construction panels. The material which can not be recycled is disposed of as landfill. It has however been impossible to receive data from the production of these construction panels. Hence, 100% recycling has been assumed but with no credit for avoided production as a conservative estimate.

Vestas has previously disposed of separation film as combustible waste. However, it is now possible to recycle separation film into new plastic material and this process has been used in the model.

Auxiliary materials such as vacuum fleece, vacuum foil and slip and bleeding foil will all be removed before assembling the blades. The vacuum fleece has collected surplus epoxy; however, the extent of this is unknown. Auxiliary materials are disposed of as combustible waste and are included

as incineration with heat recovery in the model, which is the procedure in Denmark.

Manufacturing of onshore foundation

The foundation for the onshore turbine consists of plate foundations made with reinforced concrete. Typically, the size is 15 × 15m and 2m deep. The foundation is concreted in situ. After excavation, the hole is filled with approximately 475 m³ of concrete with approximately 36 tons of steel reinforcement. Transport of concrete and reinforcement to the wind power plant area has not been included. Only materials are included in the project model.

Manufacturing of offshore foundation

The offshore foundation is similar to the foundation used for the offshore V80-2.0 MW. The turbines are placed at a depth of 6,5-13,5 m, calculated from sea surface to sea bed at average water level. In this model an average sea depth of 10 m has been used.

The foundation consists of a foundation pile, a transition piece, a boat landing platform, a platform and cathode protection.

As the dimensions for the foundation pile may fluctuate due to various sea depths, different assumptions are made as regard the dimension of the foundation. The dimensions are as follows:

Foundation pile	:	High-strength steel
Length	:	29,700mm
Diameter	:	4,000mm
Thickness	:	30mm, 45mm, 50mm

Dimensions for the transition piece are as follows:

Length	:	17,000mm
Diameter	:	4,240mm (bottom), 4,000mm (top)
Thickness	:	40mm and 50mm

Manufacturing of foundation piles and transition piece

The production of the foundation pile and the transition piece is based on experience from offshore projects. Furthermore, experience from various processes such as welding, sand blasting, etc. and from manufacturing the turbine tower has been used.

The quantity of steel has been determined on the basis of experience from offshore projects. Energy consumption has been estimated from a previous LCA study of turbines regarding production of tower. It has been assumed that energy consumption is linearly correlated to steel tonnage. It has not been possible to determine other parameters for the manufacturing process of the pile. The following data has been used for the foundation: steel, energy consumption, welding, acetylene, tetrene, atal-6, welding powder, oxygen and argon.

Surface treatment

Steel is shot blasted. Information on incoming quantities of steel grit has been supplied by experts in Vestas. For the coating of the steel a two-component thick film (epoxy) coating has been used.

Data regarding paint and surface treatment has been provided by experts at Vestas. Data on energy consumption and emissions have been modelled from the production of towers.

Assembly of foundation piles and transition piece

The transition piece has a larger dimension than the foundation pile. A concrete-based material with high-strength quality has been used for coupling the pile and the transition piece. However, it has not been possible to obtain data on the manufacturing of this special concrete material and instead data on production of ordinary concrete has been used. Data refers to Aalborg Portland's environmental statement of 1999^{vii}.

Boat landing platform and platform

Both the boat landing platform and the platform are manufactured in steel and the same quantities of incoming and outgoing materials and resources from the previous LCA projectⁱⁱ are used.

Cathodic protection

To minimise corrosion, the foundation pile has been supplied with cathodic protection inside and outside. Passive solutions of cathode protection have been selected, which means that no applied power is needed for the protection. I.e. sacrificial anodes made of aluminium are used, where the sacrificial material must be sufficient to protect the pile in its lifetime. The aluminium will precipitate as insoluble aluminium oxide^{viii}.

In connection with the erection of offshore turbines at Horns Reef, the dimension of the cathode protection (inside and outside) has been calculated. The quantity of material may vary depending on the water depth. A water depth of 6,5-13,5 m has been estimated.

The lifetime of the cathode protection has been set to 30 years for safety reasons. However, since the lifetime for foundations is 20 years, a total of 47% of aluminium will be unexploited when the foundation is scrapped. The part which has been exploited in the LCA model is included in the operation of the foundations. For the protection system, all incoming cables are included, e.g. copper in the cables. It has not been possible to include a complete material composition and/or lifecycle of the cables. All cables are made of copper and are included in the project model as pure copper.

Manufacturing of internal cables to offshore wind power plant

32 kV PEX submarine cables are used as internal cables, i.e. between the turbines and between the turbine farms and the 32/150 kV transformers.

Data regarding the manufacturing of cables has been obtained from the supplier's data sheet for this cable. The cables contain copper, lead, steel and insulator. The insulator is assumed to be polyethylene. All the materials are found in the LCA database.

Manufacturing of transformer station to offshore wind power plant

The foundation for the platform has a 20-year lifetime as it is assumed that the wind power plant will be replaced by a new one using the same transformer station. The foundation consists of three piles; two of these with a diameter of approximately 1.6 m and a pile with a diameter of 2.3 m. The three foundation piles are mutually combined via lattice girders.

The platform is placed approximately 14 m above mean water level and holds a height of approximately 7 m. The ground dimensions are 20 × 28 m. The steel superstructure is covered on the

sides to create shelter on the platform. A helicopter platform is placed on top of the platform.

The superstructure is assembled onshore and transported to the offshore wind power plant as a single module. The module is placed on the substructure by means of a floating crane.

The foundation and the platforms consist of steel, stainless steel, aluminium and reinforced concrete. The LCA database contains data on all these materials.

The transformer primarily consists of oil, tin, copper and steel. LCA data can be found in the LCA database regarding these materials.

Manufacturing of 150 kV PEX submarine-/onshore cable and SF6-system for offshore wind power plant

Two 150 kV PEX cables with a 40-year lifetime are used for transferring electricity from the offshore transformer station to the connection of the power transmission grid via the cable transition station onshore. Here it is also assumed that the wind power plant will be replaced by a new one using the same 150 kV PEX cables.

The length of the cables from the offshore transformer station to the cable transition station is approximately 20 km; and from the transition station to the connection of the 150 kV transmission grid there is approximately 34 km. In other words, 20 km of the cables are submarine cables and the remaining 34 km are onshore cables.

The submarine cables start at the transformer platform at the offshore wind power plant and ends onshore where the cables are pulled approximately 1,000 metres onshore. The submarine cables are subsequently connected to the onshore cables in a cable transition station and the onshore cables are then wired to a 150 kV transformer station. Apart from the transition between the two cable types, the transition station also contains a fixed coupled output coil for compensation of the cable's generated reactive effect.

The cable transition station has been established as a capsular SF6-system in order to minimise the dimension of the site. The building for this facility is very simple and has not been included in this LCA as it has been estimated to be insignificant. Primarily cast iron, oil, copper and steel have been used for the manufacturing of the cable transition station.

The submarine cables in the trace are 150 kV three-conductor, PEX cables equipped with a sea armouring of steel wires. The submarine cables primarily consist of lead, copper, steel and plastic.

Onshore cables will be equipped with one-conductor PEX isolated cables with 1,200 mm². This implies that three onshore one-conductor cables are needed for one three-conductor offshore cable.

Each of the one-conductor cables weighs approximately 9 kg/m and has a diameter of 90 mm. The primary materials of the onshore cables are aluminium, copper and plastic and also sand and concrete for the cable channel.

During the manufacturing process a 50km onshore transport has been estimated from the material supplier to the cable factory.

Resource consumption for wind power plants

The largest quantities of materials used in the life cycle of a wind turbine and the transmission respectively (including internal cables) are shown in table 4.

Materials	Materials for offshore wind power plant		Materials for onshore wind power plant	
	Offshore turbine	Transmission	Onshore turbine	Transmission
	(kg/turbine)	(kg/farm)	(kg/turbine)	(kg/farm)
Water	1.13E+07	1.88E+08	7.46E+06	1.11E+05
Hard coal	1.86E+05	1.65E+06	9.67E+04	0.00E+00
Iron	1.17E+05	4.84E+04	6.23E+03	3.17E+01
Crude oil	9.96E+04	6.56E+06	7.94E+04	1.07E+04
Quartz sand	9.33E+04	5.45E+04	9.27E+04	1.80E+00
Lignite	7.63E+04	1.16E+06	5.15E+04	4.30E+02
Natural gas	8.75E+04	1.35E+06	6.22E+04	3.39E+03
Limestone	3.40E+04	1.14E+05	1.48E+04	3.02E+02
Sodium chloride	1.32E+04	7.38E+04	1.28E+04	2.60E+02
Zinc	1.12E+04	2.44E+04	2.08E+03	0.00E+00
Clay	8.37E+03	2.11E+04	8.37E+03	1.52E-01
Stone	2.80E+03	1.25E+06	5.57E+05	0.00E+00
Manganese	2.52E+03	1.33E+04	1.89E+03	1.90E-01
Aluminium	1.95E+03	1.22E+05	7.81E+02	1.29E+02
Copper	5.51E+02	2.03E+05	5.25E+02	5.32E+02
Lead	4.33E+00	8.60E+04	4.17E+00	0.00E+00

Table 4: Significant resource consumptions in the project model of offshore- and onshore wind power plants, respectively. Note that statement of materials for the turbines is stated per turbine, while the materials for the transmission system are stated for the total transmission system, i.e. per wind power plant.

Life cycle impact assessment

The life cycle survey of offshore and onshore wind power plants has been used to make a calculation of environmental impacts for the two wind power plants. The calculation has been made with the EDIP methodology in the LCA tool GaBi.

Environmental impacts

The potential environmental impacts included in this study can be divided into three groups as shown below.

Environmental impacts:

- Global warming
- Ozone-depletion
- Acidification
- Nutrient enrichment (eutrophication)
- Photochemical ozone formation (smog)

Toxicity:

- Human toxicity
- Eco-toxicity

Waste:

- Bulk waste
- Slags and ashes
- Hazardous waste
- Radioactive waste

Global warming is the atmosphere's ability to reflect a part of the heat radiation to the earth. Global warming is increased by the atmosphere's content of carbon dioxide, CFC, laughing gas and methane, among others. Increased emission of these substances might impact the heat balance of the earth and over the next decades this may result in a warmer climate.

Ozone depletion: Formation and depletion of ozone is naturally in balance in the earth's stratosphere 15-40km up in the atmosphere. But the depletion will increase due to the emission of halocarbons, i.e. organic compounds, which contain chlorine or bromine and which are persistent enough to reach the stratosphere. The reduced amount of ozone in the stratosphere means that more harmful UV-rays in the sunlight will reach the surface of the earth. These UV-rays can for example cause skin cancer and have a negative effect on crop yields.

Acidification means that acids and compounds, which can be transformed into acids are emitted into the atmosphere and subsequently deposited in water and soil environments, which means that the admission of hydrogen ions decline (pH decline), e.g. the degree of acidity will be increased. This will for example result in negative consequences for coniferous trees and fish by way of forest die-back and death of fish, and furthermore this will result in corrosion damages on buildings, metals, etc.

Nutrient enrichment is an impact on eco systems with substances, which especially contains nitrogen (N) or phosphorus (P). The consequence might be a disturbed biological balance, where growth of some organisms takes place at the expense of other life forms. Oxygen depletion is a known consequence of nutrient enrichment, but also reduction in moorlands and other nutrient-poor ecosystems is seen due to nutrient enrichment.

Photochemical ozone formation (smog) is caused by degradation of organic compounds (VOC) in the presence of light and nitrogen oxide (NO_x). Exposure of plants to ozone may result in damage of the leaf surface, leading to damage of the photosynthetic function, discolouring of leaves, dieback of leaves and finally the whole plant. Exposure of humans to ozone may result in eye irritation, respiratory problems, and chronic damage of the respiratory system.

Human and Eco-toxicity: Some substances are not very biodegradable and can reach relatively high concentrations, which cause toxic effects on humans or on eco systems in various places in the environment both in the soil- water and air environment. Modelling of toxicity in a LCA is very difficult because of the complexity of chemicals in the environment. There is no international consensus on how to do this, and the results are very uncertain. However, in this study it has been chosen to include impacts from chemicals – even though the results regarding this shall be interpreted with potential large uncertainties in mind.

Eco-toxicity: see above.

Bulk waste is construction waste and similar waste which is deposited at controlled waste deposits. This waste is characterised by the fact that it does not contain environmentally hazardous substances.

Slag and ashes is the by-product of incineration processes. Slag and ashes is usually disposed of at special waste disposal sites.

Hazardous waste is waste which must be brought to special processing plants or to a special deposit for hazardous waste. This waste is characterised by the fact that it contains environmentally hazardous substances, which may be released during the stay at the deposit.

Radio active waste is waste of low radiation intensity from nuclear power plants. One of the major problems associated with radioactive waste is the fact that much of it will be radioactive for hundreds of thousands, if not millions, of years, and thus will require isolation from the human environment.

For further descriptions we kindly refer to the documentation for the EDIP methodology ⁱⁱ.

Calculation method

By means of the GaBi pc-tool a normalisation of environmental impacts has been made. I.e. environmental impacts are stated in person equivalents (PE). The results reflect what 1 kWh power produced from the wind power plants through their lifetime make up of an average citizen's total impact^{ix}. This means that environmental impacts of power from wind power plants are related to a standard citizen's average contribution to the individual environmental impacts.

By normalising environmental impacts it is possible to assess the relative contribution of different environmental impacts from the production of electricity from wind turbines. However, a weighing

of the different environmental impacts against each other is not performed, since no consensus for a weighing system exists. Weighing environmental impacts will thus be a subjective evaluation.

The normalisation carried out is based on EDIP 1997 (90/00) which means that 1990 is the reference year for normalisation.

Results

This section presents the main result of the LCA on V90-3.0 MW based offshore and onshore wind power plants.

Where data from components or materials are missing, the rest of the materials used in the superior component are scaled up according to data found in product specifications. Hereby, it is ensured that 100% of the actual weight of the wind system is included in the LCA.

Resource consumption per kWh produced

The life cycle inventory can be added up in a statement of resource consumption for the total lifetime of the wind power plant per kWh of produced electricity.

Offshore wind power plant		Onshore wind power plant	
Resource	Quantity [g/kWh]	Resource	Quantity [g/kWh]
Water (fresh)	49.346	Water (fresh)	51.231
Hard coal	0.740	Stone	3.531
Crude oil	0.630	Hard coal	0.643
Iron	0.419	Quartz sand	0.588
Natural gas	0.375	Crude oil	0.541
Quartz sand	0.335	Natural gas	0.420
Lignite	0.324	Lignite	0.344
Limestone	0.126	Limestone	0.096
Sodium chloride (rock salt)	0.051	Sodium chloride (rock salt)	0.084
Stone	0.055	Clay	0.054
Zinc	0.041	Iron	0.040
Clay	0.031	Zinc	0.013
Aluminium	0.011	Manganese	0.012
Manganese	0.010	Aluminium	0.005
Copper	0.009	Copper	0.004
Lead	0.003	Chromium	0.002

Table 5: Significant resource consumption of 1 kWh electricity from offshore and onshore wind power plants, respectively.

For both the offshore wind power plant and the onshore wind power plant the largest resource consumption is water. Water is used in several production processes by sub-suppliers and in connection with material production, i.e. the manufacturing of PUR glue and the production of electricity at conventional power plants.

Hard coal, crude oil, lignite and natural gas are all energy resources used as energy sources primarily

in the production of turbines. Crude oil – is furthermore used as transformer oil and as a component in the production of plastics here among epoxy for the blades. Stone in the form of broken granite and calcium are used for the concrete foundation of the onshore turbine and for the cable channels.

Iron is also one of the most used resources and is furthermore the most used metal. Iron is used to produce steel which is applied in large quantities on the wind power plants.

Quartz sand is used in the production of cast iron components e.g. in the hub and the foundation in the nacelle.

Limestone is primarily used in the production of steel.

Zinc is used in the metallizing of e.g. the tower and the offshore foundation for the V90-3.0 MW.

For the offshore wind power plant aluminium is primarily used for the foundation of the transformer station, in the cable transition station and for the submarine cable.

For the onshore wind power plant aluminium is primarily used in the nacelle and in cables.

Energy consumption per kWh produced

From the resource statement of the wind power plant's life cycle, energy consumption per turbine including grid connection has been calculated, i.e. manufacturing, operation, transport, dismantling/disposal and transmission. In the statement, all energy resources have been included for the entire wind power plant's life cycle. These quantities are recalculated by means of gross calorific value to energy.

The calculations of the energy consumption, by means of LCA, for offshore and onshore wind power plants have been shown in table 6. The calculations show that the energy consumption per offshore turbine is 8,098,391 kWh. In the section "Offshore wind power plant" it is established that one turbine generates 14,230,000 kWh/year. The calculations show that the energy consumption per onshore turbine is 4,304,221 kWh. In the section "Onshore wind power plant" it is established that one turbine delivers 7,890,000 kWh/year.

Energy consumption [MJ/kWh produced]	Offshore	Onshore
Fossil fuels		
Crude oil	2.87E-02	2.46E-02
Hard coal	2.25E-02	1.95E-02
Lignite	3.17E-03	3.38E-03
Natural gas	2.02E-02	2.24E-02
Nuclear power	2.02E-02	2.05E-02
Renewable energy		
Biomass, dry matter, fuel	8.68E-04	7.29E-04
Biomass, dry matter, raw material	1.43E-05	2.54E-05
Hard wood, dry matter, raw material	7.09E-05	1.26E-04
Primary energy from hydro power	5.49E-03	6.07E-03
Primary energy from wind power	2.54E-07	4.51E-07
Renewable fuels	1.17E-08	2.08E-08
Total (MJ/kWh produced)	1.02E-01	9.82E-02
Total (kWh/kWh produced)	2.85E-02	2.73E-02
Total (kWh/turbine) in the lifetime	8,098,391	4,304,222

Table 6: The energy consumption of offshore and onshore V90-3.0 MW wind power plants.

Emissions to air and water per kWh produced

The table below shows the most significant emissions to air and water for both offshore and onshore wind power plants.

Emissions [g/kWh produced]	Offshore	Onshore
Emissions to air		
Carbondioxide (CO2)	5.23E+00	4.64E+00
Sulphur dioxide	2.15E-02	2.18E-02
Nitrogen oxides	2.06E-02	1.77E-02
Carbon monoxide	1.99E-02	8.13E-03
Organic emissions to air (group VOC)	1.25E-02	1.47E-02
Nitrous oxide (laughing gas)	1.73E-04	1.82E-04
Hydrogen chloride	1.21E-04	1.80E-04
Nitrogen (N2)	1.03E-04	7.26E-05
Hydrogen	9.48E-05	1.56E-04
Hydrogen sulphide	7.45E-05	3.18E-05
Manganese	7.02E-05	2.04E-05
Emissions to water		
Total N	2.58E-06	1.46E-06
Total P	3.20E-08	2.93E-08
Chemical oxygen demand (COD)	2.41E-03	2.57E-03

Environmental impacts of 1 kWh

The main result of this LCA is the environmental impacts of 1 kWh electricity from offshore wind power plants and onshore wind power plants, respectively. These are classified in below figure and the actual numbers can be seen in appendix 1.

Comparison of environmental impacts of one kWh from V90 onshore and V90 offshore

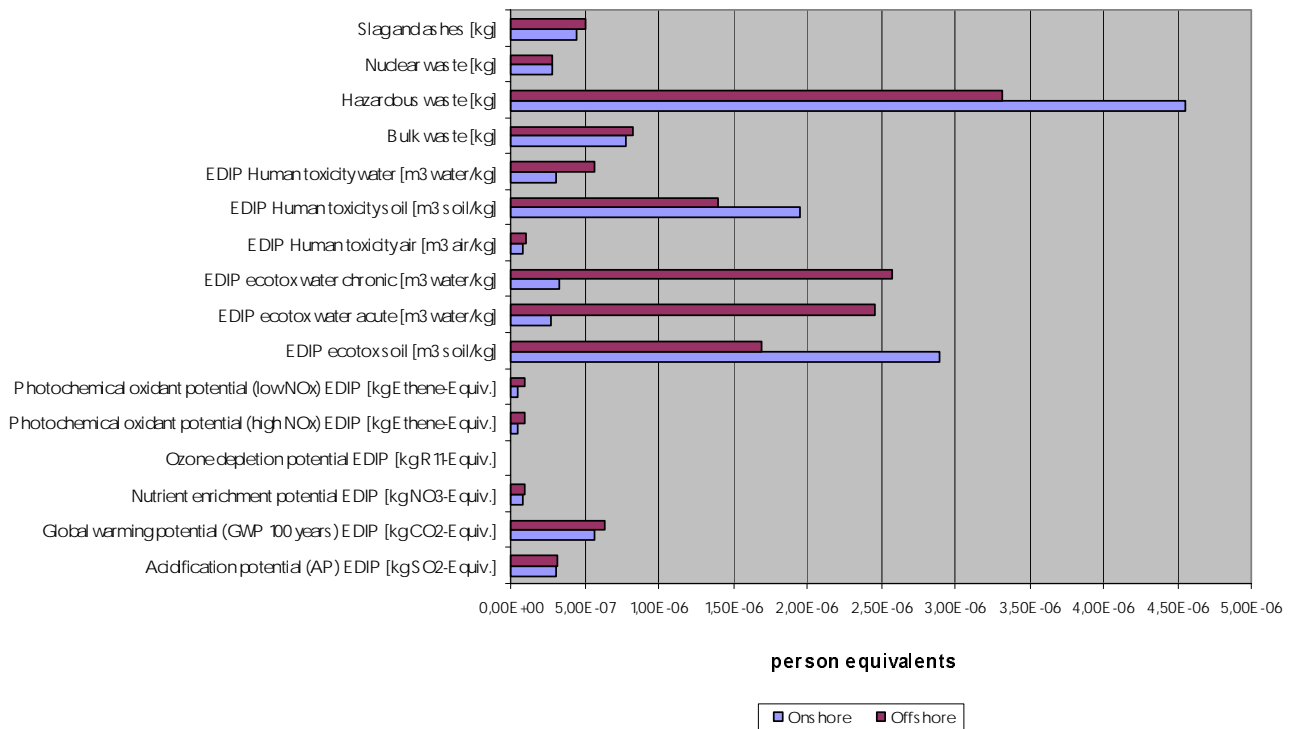

Figure 10: Environmental profiles of 1 kWh electricity from offshore wind power plants and onshore wind power plants.

Figure 10 shows that the environmental profile of 1 kWh from the onshore wind power plant and the offshore wind power plant, respectively, is relatively identical. However the impact for hazardous waste, human toxicity soil and eco toxicity soil is significantly higher for the onshore wind power plant than for the offshore wind power plant. Similarly, for Ecotox water cronic and Ecotox water acute the impact is significantly higher for the offshore wind power plant than for the onshore wind power plant. However, toxicity scores shall in general be interpreted with care due to large uncertainty factors.

The offshore wind turbine produces more electricity than the onshore wind turbine. However, it is more resource demanding to establish offshore wind power plants. These two parameters almost outweigh each other and the global warming potential is as such almost the same for offshore and onshore wind power plants per kWh.

However, a difference can be seen for hazardous waste, human toxicity soil and eco toxicity soil because the higher electricity production offshore is not outweighed by an equal decrease in the hazardous waste, human toxicity soil or eco toxicity soil.

For ecotox water chronic and ecotox water acute emissions to water take place during the operation

stage, see figure 11, i.e. zinc is discharged from the offshore cables during the operation stage.

Environmental impacts divided into life cycle stages

A division of environmental impacts on the life cycle stages can be seen from the following figure in which both onshore wind power plants and also offshore wind power plants are presented.

A positive as well as a negative scale can be read in the figure. This means that dismantling and removal show a negative result which must be deducted from the positive column. Subsequently, the final, normalised potential environmental impact (as seen in figure 10) can be obtained. The reason why dismantling and removal give cause for reductions in impacts is that recycling is used to a high degree. I.e. the quantity of materials is credited and returned to the technosphere by means of recycling. Included in dismantling and removal is the environmental burdens of dismantling, transport and processing of materials so that the materials are ready for new use.

Environmental impacts from 1 kWh from V90 offshore divided on stages

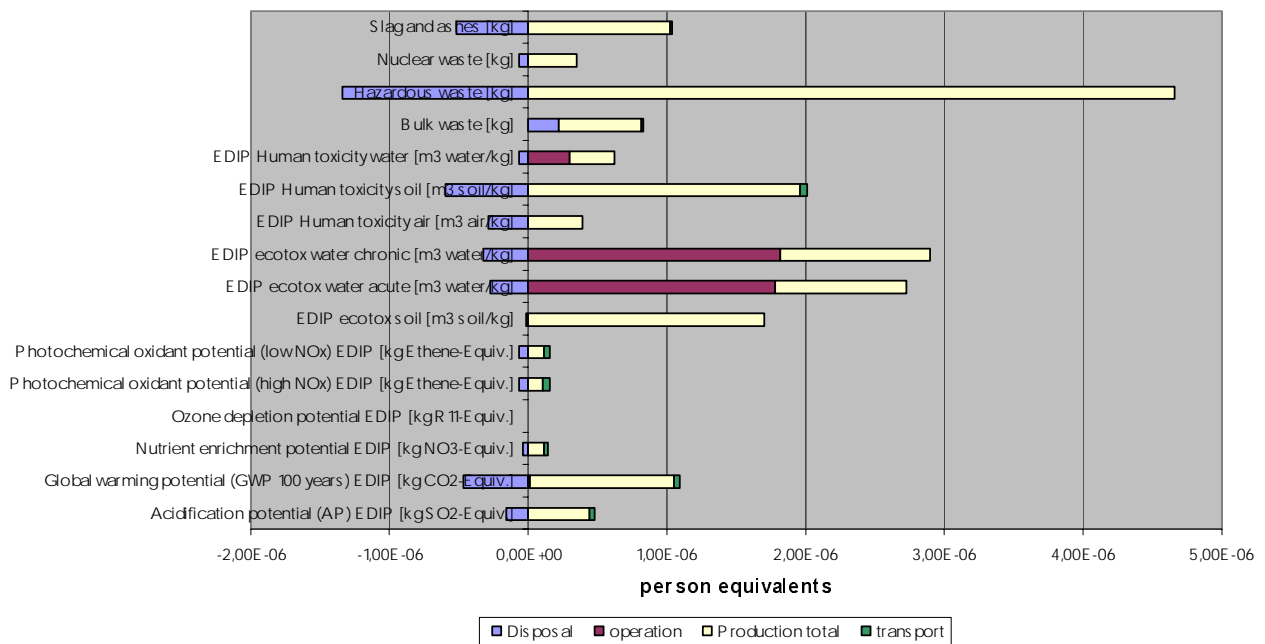

Environmental impacts from 1 kWh from V90 Onshore divided on stages

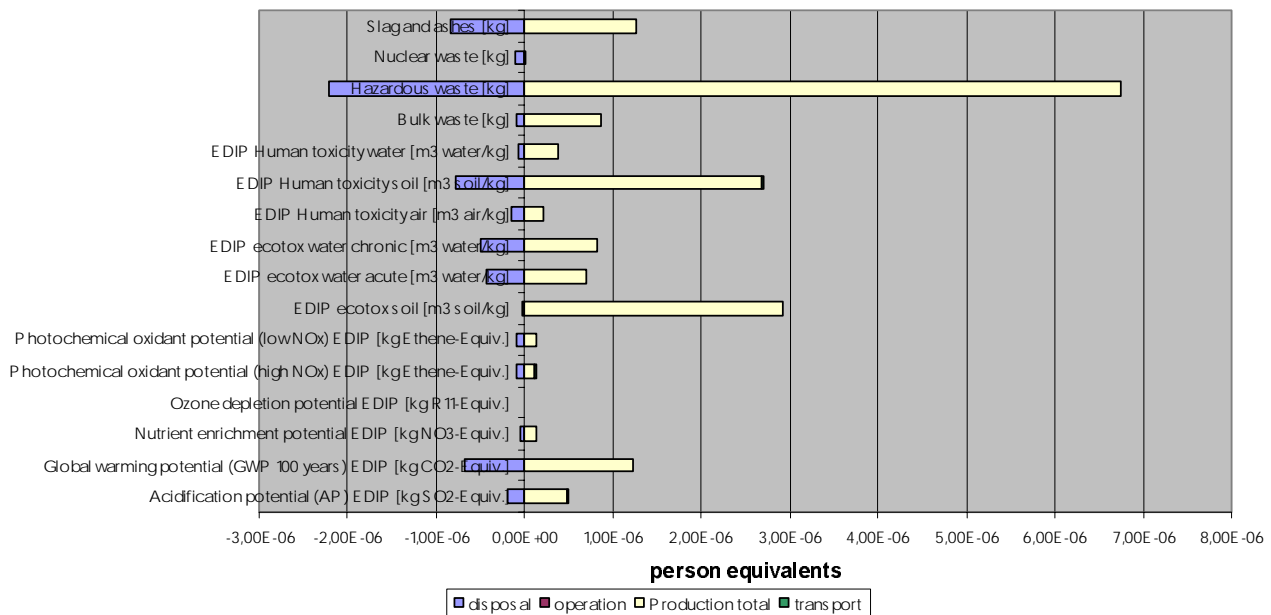

Figure 11: 1 kWh electricity from offshore wind power plants and onshore wind power plants divided into life stages.

Not surprisingly, the manufacturing stage is significant for the environmental impacts of electricity generated by turbines, both for offshore wind power plants as well as onshore wind power plants. At the same time it is important to conclude that disposal of materials is important for the environmental profile of electricity generated from wind power plants. Environmental impacts will change if less recycling is assumed.

Environmental impacts from the operational stage are significant for the offshore wind power plant as the emission into water takes place during the operational stage. Zinc is e.g. discharged from offshore cables during the operational stage. As described in the chapter “Environmental impacts” modelling of toxicity in a life cycle assessment is very difficult because of the complexity of chemicals in the environment. There is no international consensus on how to do this and the results are very uncertain. The values of operational stages should therefore be interpreted with the potential large uncertainties in mind.

Comparison with European electricity

In order to relate the environmental impacts to the average European electricity generation we have decided to compare 1kWh electricity from the offshore wind power plant and the onshore wind power plant, respectively, with average European electricity '90 found in the EDIP database.

Comparison of 1 kWh from V90-3.0 offshore, V90-3.0 onshore and European electricity

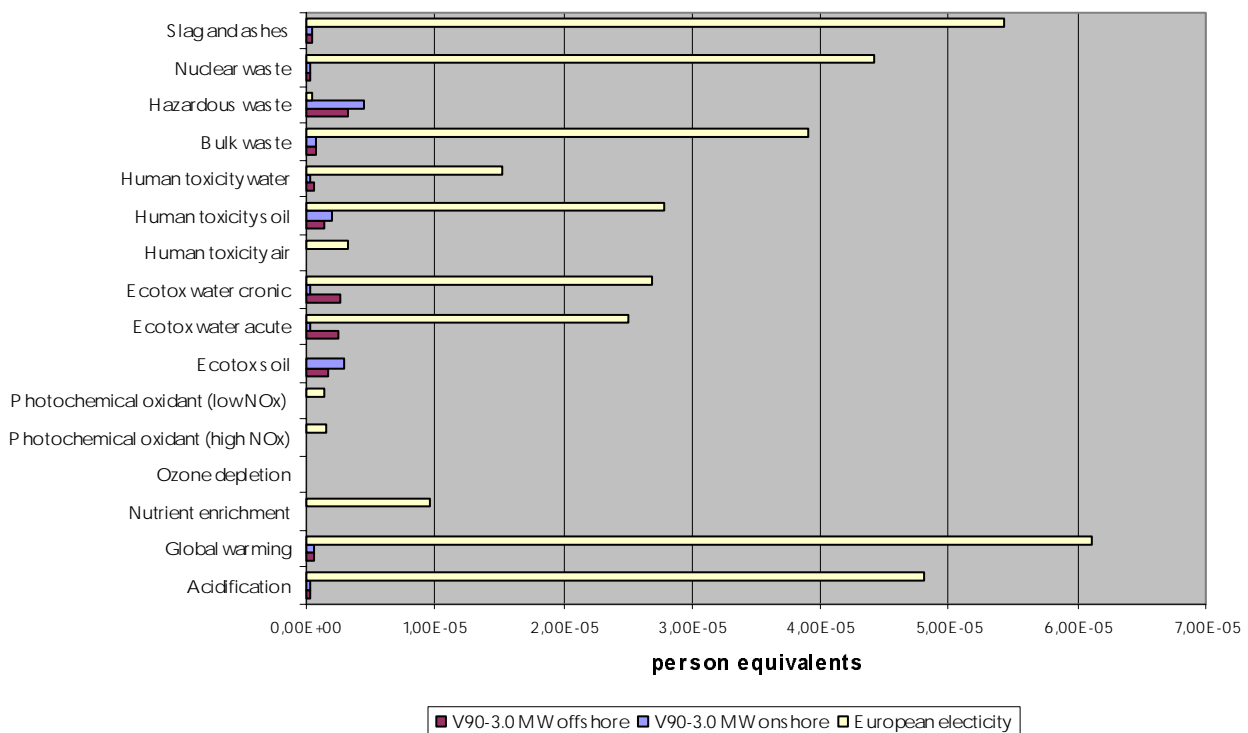

Figure 12: Comparison of 1 kWh electricity generated from V90-3.0 MW offshore, V90-3.0 MW onshore and average European electricity.

Data for European electricity presented in the figure has been modified in such a way that the grid loss of 10% electricity is not included. This has been done to standardise functional units to be able to make equal comparisons.

As the above figure shows, environmental impacts of turbine electricity generated by an offshore wind power plant and an onshore wind power plant respectively are considerably lower than from European average electricity in 1990. Of course, it is not really fair to compare 1 kWh average electricity generated in 1990 with 1 kWh of electricity generated by wind turbines in 2005-2025. However, the comparison is made to see the order of magnitude. At present, the EDIP database does not include recent data for European electricity that is reliable.

Energy balance

One of the most significant aspects of the assessment of wind turbines is the product's energy balance. The energy balance is an assessment of the relation between the energy consumption of the product and the energy production throughout the lifetime.

The energy balance has been calculated as the relation between the turbine's energy consumption for manufacturing, operation, transport, dismantling, disposal and the expected average energy production. See table 6 for the total energy consumption of offshore and onshore wind power plants.

Energy balance for the offshore V90-3.0 MW turbine:

$$\frac{8,063,418 \text{ [kWh/turbine]}}{14,230,000 \text{ [kWh/turbine.year]}} = 0.57 \text{ years} \approx 6.8 \text{ months}$$

Energy balance for the onshore V90-3.0 MW turbine:

$$\frac{4,304,222 \text{ [kWh/turbine]}}{7,890,000 \text{ [kWh/turbine \cdot year]}} = 0.55 \text{ years} \approx 6.6 \text{ months}$$

From the above calculation it can be seen that the energy balance for the offshore V90-3.0 MW turbine is approximately 0.3 months longer than for the onshore V90-3.0 MW turbine. This difference is due to a larger transmission grid and larger steel consumption for the foundations.

Interpretation of results

The data quality of the data which has been used in the present LCA has been estimated to be satisfactory for the goal of this LCA despite some lacks and assumptions. However, we estimate that for the most significant areas the data has been found valid.

For the most significant assumptions and data uncertainties, sensitivity analyses have been performed in the chapter “Sensitivity analysis”.

Disposal and recycling

Since the last LCA ⁱⁱ was published, progress has been made regarding the disposal of blades. Until recently, blades were assumed to be delivered to a waste disposal site for landfill, simply because no recycling methods were available. This meant that the blades represented a large contribution to the environmental impact ‘bulk waste’ (26.1% for the V80-2.0MW onshore wind turbine and 17.4% for the V80-2.0 MW offshore wind turbine).

However, due to a project Vestas has participated in along with among others H.J. Hansen Genvindingsindustri A/S, it is now possible to make use of energy content in the blades by incineration with heat recovery. This solution has been used in this study.

It has furthermore been possible to find theoretical recycling options for the glass fraction in the blades. However, since no practical solutions for the glass fractions have been implemented landfill of the glass content (after incineration) has been used in the baseline model as a conservative estimate.

The correct scenario to use would be the disposal situation in 20-30 years. However, it is not possible to predict the long term disposal technology.

In order to estimate the importance of depositing blades we have made calculations of three various scenarios on how to dispose of the blades:

- 100% depositing of blades.
- Incineration of blades without the possibility of recycling the glass fraction. However, steel content in the blade is recycled.
- Incineration of blades with 100% recycling of the glass fraction (recovery of 90%, the rest is

disposed of as landfill). Resources for processing of the glass fraction are not included.

Calculations have been made for the total lifetime of the rotor (three blades and the hub) and assessed for 1 kWh. This calculation has been made for the onshore wind power plant, but the differences between the three scenarios are identical for the two farms, as they have identical turbine types and blades.

Comparison of environmental impacts for waste scenarios for the V90-3.0 MW blades

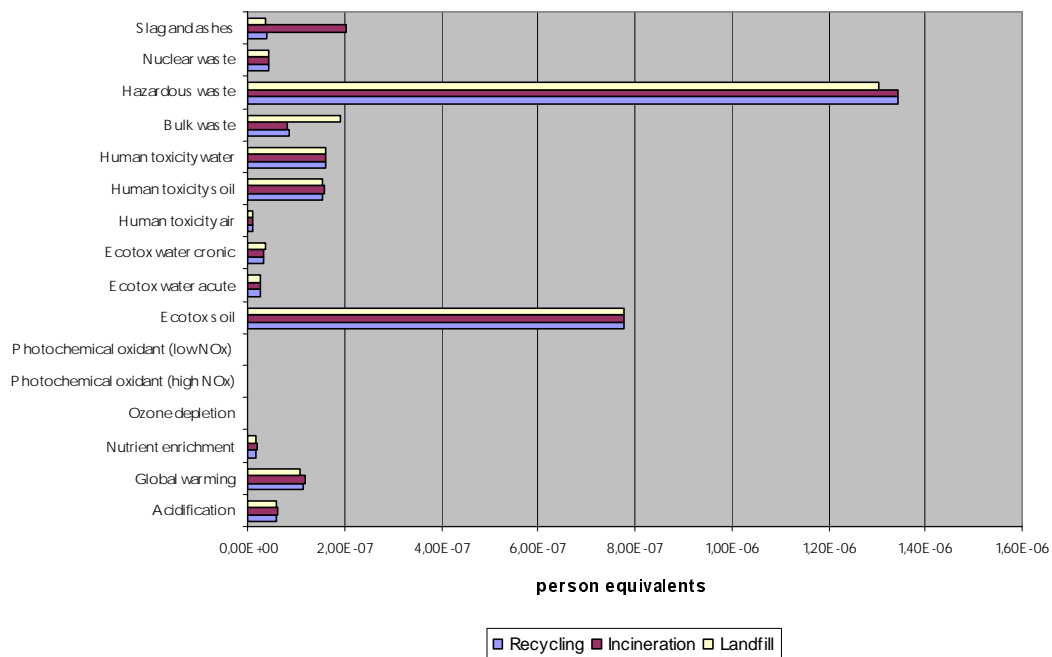

Figure 13: Environmental impacts of various scenarios for disposal of blades.

The comparison of the three disposal scenarios shows that there are only minor differences regarding environmental impacts, apart from the category ‘bulk waste’. Bulk waste is of course significantly larger when the blades are deposited. Incineration of blades also generates a very large quantity of waste as the fibre glass in the blades is not combustible and therefore ends as a residual product from the incineration procedure. This residual product is defined as slag and ashes.

If the energy gross for the three scenarios are calculated the improvement from landfill to incineration and recycling is approximately 3% and 6% respectively for the rotor. This implies, seen from a life cycle perspective, that energy consumption is approximately 6% lower when recycling the materials in blades in relation to landfill of the entire rotor.

Sensitivity analysis

The most significant assumptions for the two turbine farms are the energy production, the lifetime of the wind power plants, processing of steel components and the degree of recycling of metals as they clearly show the effect on the environmental impacts of 1 kWh. The choice of site conditions expresses a realistic site placement and the lifetime is based on the design lifetime of the V90-3.0 MW wind turbines. Data for processing is partly from the EDIP database and partly from suppliers.

Energy production

Figure 14 shows global warming in relation to energy production. I.e. it is possible to see the variation of environmental impacts within the normal production frames for the wind power plants.

Global warming has been singled out to be looked at as global warming represents the energy consumption.

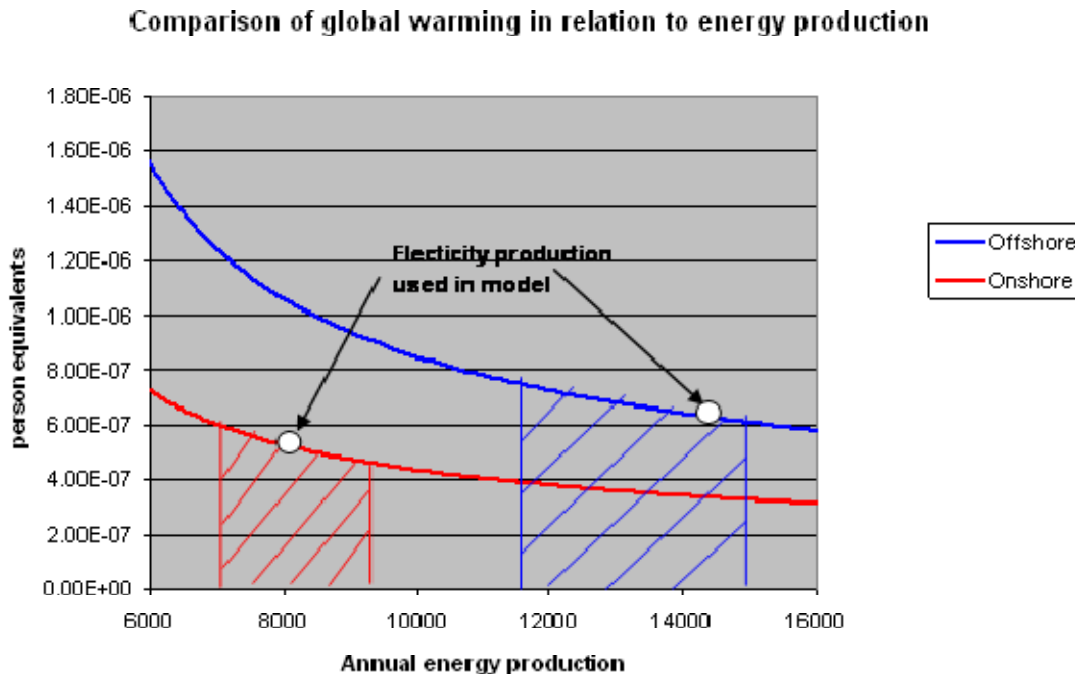

Figure 14: Comparison of global warming in relation to energy production. The annual production of the offshore wind turbine is 14,230,000 MWh and for the onshore wind power plant the production is 7,890,000 MWh. Besides electric power generation everything else is kept invariable.

The figure shows that production is important for the environmental impacts stated per kWh. The calculation presumes that all factors except electric power generation are equal. I.e. no considerations have been made for a better wind location which could require increased material consumption in connection with construction, longer cables, other foundations, etc.

Experience show that it is realistic if an onshore wind power plant's annual production area is between approximately 6,900 MWh/turbine and 9,100 MWh/turbine. An offshore wind power plant's annual production is between approximately 11,300 MWh/turbine and 14,800 MWh/turbine depending on the siting of the wind power plants both onshore and offshore. This reflects that both the offshore wind power plant and the onshore wind power plant have been sited in realistic locations. It should, however, be noted that wind power plants are also placed at sites outside the mentioned intervals.

As the figure shows the site for the offshore wind power plant expresses an above average placement. This is due to the use of data from the site Horns Reef in Denmark.

Data for processing materials

A lot of efforts have been used to obtain energy consumption data from sub-suppliers. Contrary to

previous reports this LCA contains data from casting of cast iron items, sand blasting, metallizing and painting of metal and production of transformers. However, data for processing is still missing from some sub-contactors, i.e. the production of steel plates for tower sections, the manufacture of other steel components and the processing of copper. In the case of steel components general data for the manufacture of steel profiles have been used. In the case of copper components it has not been possible to obtain data for this project. Sensitivity analyses has been prepared for both assumptions.

The below figure shows the three scenarios for the offshore wind power plant, where the input and output for the processing of steel components have been altered:

- Half input and output in the manufacture of steel components
- Current scenario
- Double input and output in the manufacture of steel components

Comparison of environmental impacts in relation to the significance of data for steel processing

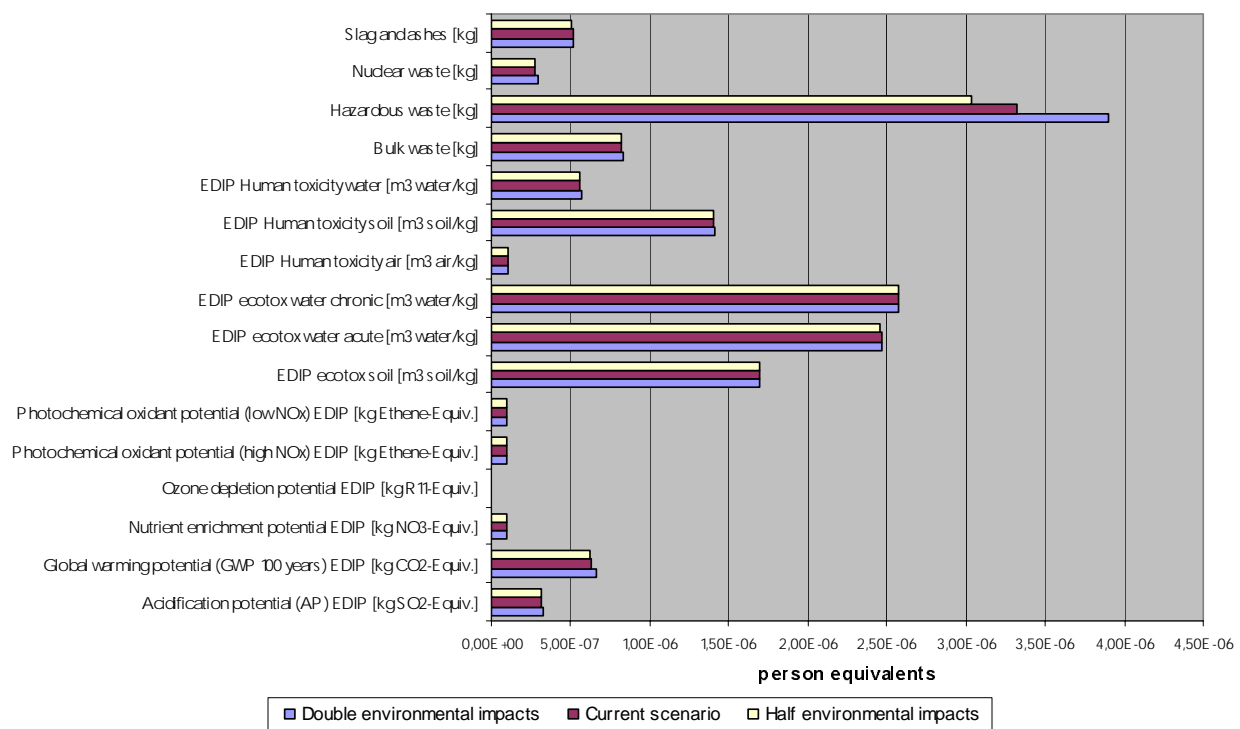

Figure 15: Comparison of environmental impacts in relation to the resource consumption for processing steel components.

The above figure shows that the data for processing steel mainly has an impact on hazardous waste. The environmental impact of hazardous waste increases by approximately 17% when resource consumption for processing steel components is doubled and decreases by approximately 9% when resource consumption for processing steel components is halved. As such it can be said that data for steel must be as accurate as possible as steel is one of the most used materials in the finished wind turbine.

Copper is mainly used in cables in the transmission part of the model. Data for steel processing has

been applied to all copper components in the transmission. The below figure shows:

- Current scenario
- Processing of copper in transmission

Comparison of environmental impacts in relation to inclusion of data for processing copper in the transmission

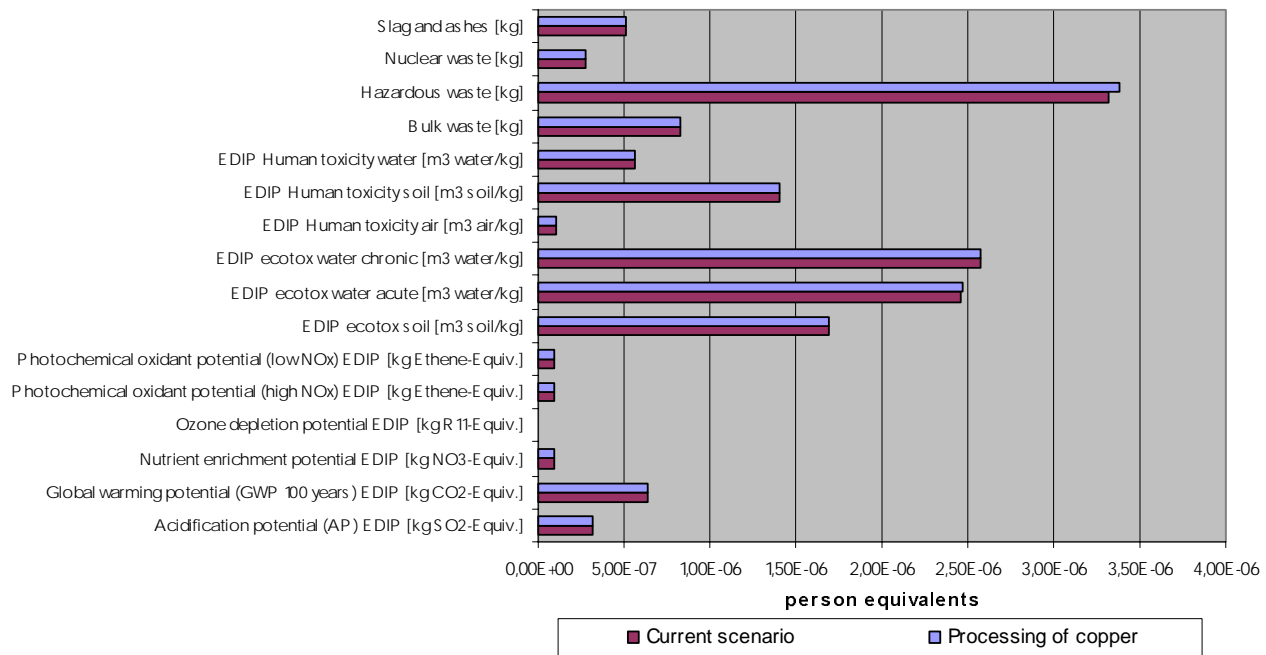

Figure 16: Comparison of environmental impacts in relation to current scenario and a similar scenario where processing of copper in the transmission is included.

In the figure it can be seen that processing of copper does not have a significant influence on the environmental impact of the offshore wind power plant. For the onshore wind power plant the total copper usage is not as high as for the offshore wind power plant due to a smaller transmission.

Figures 15 and 16 show that steel is more vital than copper or aluminium as steel is the largest incoming metal in the construction of the wind power plants both offshore and onshore as seen in table 5.

Location

If you imagine similar wind power plants erected in other locations, the conditions in some areas would be very different. In Denmark onshore sited wind power plants will only be sited at a short distance from the existing electricity grid - in this case 140km of cables has been used, whereas this is not the case in other countries. To illustrate the importance of this factor on the LCA model, the result of the onshore V90-3.0 MW wind power plant has been compared with a calculation where it has been assumed that the turbines have been placed further away from the electricity grid, and therefore 420km of cables is required. In below calculation the electricity production has been assumed to remain the same and no grid loss has been included in either scenarios.

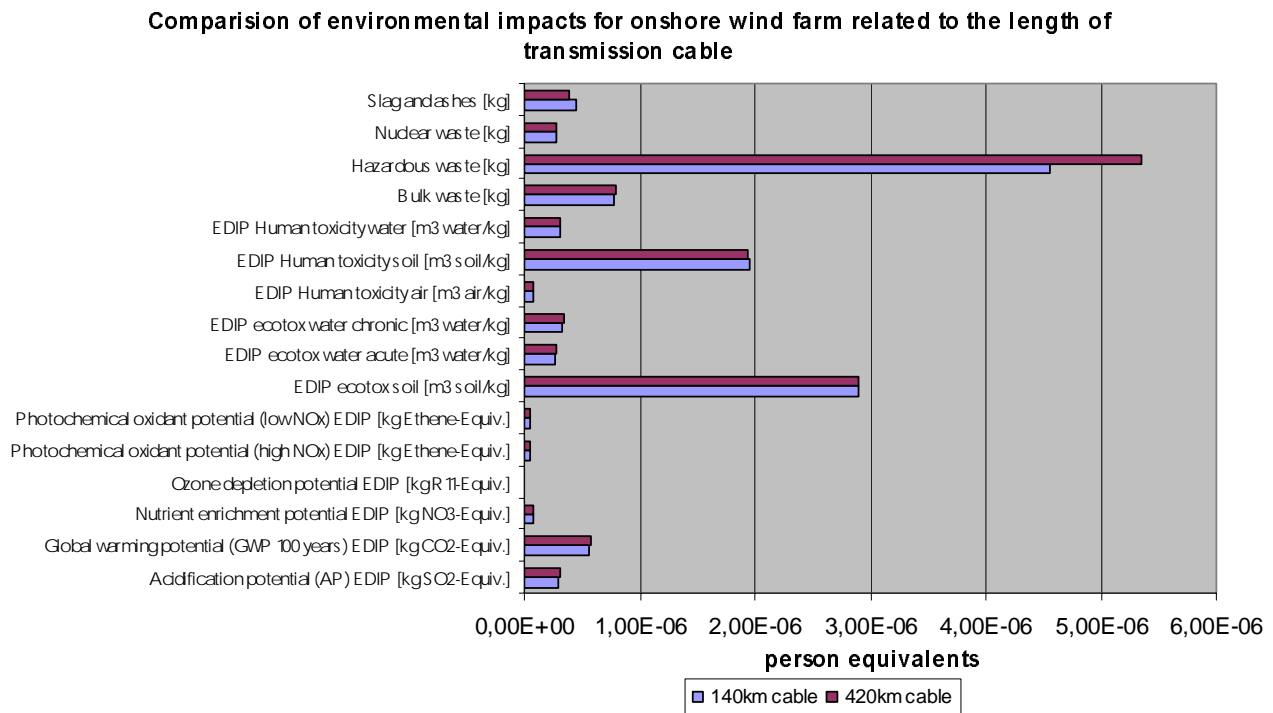

Figure 17: Comparison of environmental impacts of onshore sited wind power plant with various distances to the electrical grid.

The above figure shows that cables only have little impact on the total environmental impacts of the onshore wind power plant. As the figure shows it is decisive how big the energy production of the onshore wind power plant is.

If you assume that an offshore wind power plant is similar to the one used in the LCA but sited at another location and with a different distance to the shore, the loss in the cables will be different.

In the following, a wind power plant similar to the wind power plant in this LCA has been assumed to be sited with double the distance from the shore as the wind power plant used in this LCA. A simple assumption is that the net loss is linear with the length of cables. I.e. the net loss is doubled when the distance is doubled as the major part of the net loss takes place in the cables. Furthermore, the foundation has been changed. A very simple assumption has been made about the foundation as its weight has been assumed to change +20%. The following scenarios have been calculated:

- The actual location of the wind power plant
- Double distance to shore, double net loss
- 20% increase of foundation

Comparison of environmental impacts for offshore wind farm related to the length of transmission cable

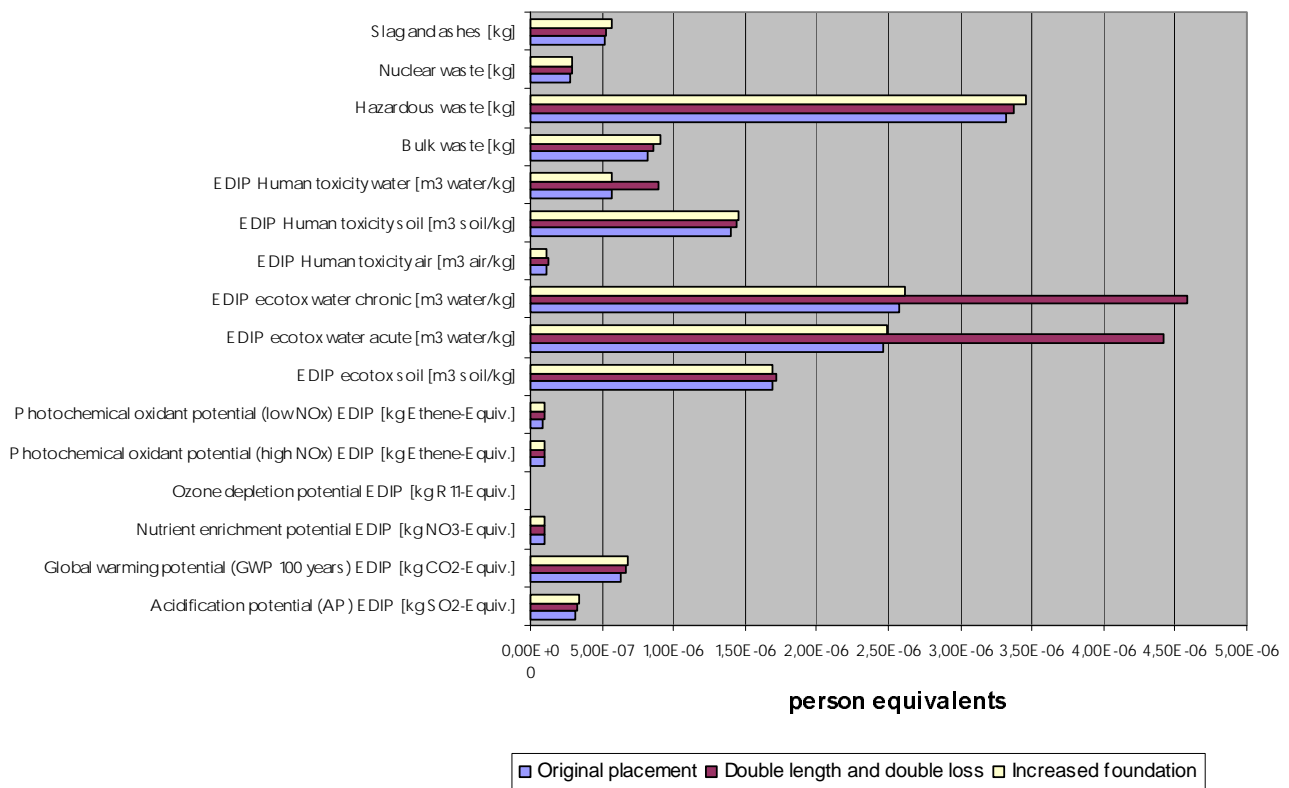

Figure 18: The importance of the location of the offshore wind power plant in relation to environmental impacts.

Under the very simple assumptions regarding the changes, which take place in connection with alternative locations of a wind power plant, it has been found that there is some impact of the location but no significant changes, except from human toxicity water and eco toxicity water. For human toxicity water and eco toxicity water the increased length of the cable also implies an increase of the emission of zinc from the offshore cables. As described in the chapter “Environmental impacts” modelling of toxicity in life cycle assessment is very difficult because of the complexity of chemicals in the environment. The values for human toxicity and eco toxicity should therefore be interpreted with the potential large uncertainties in mind.

Again, it has been concluded that energy production is one of the most significant parameters of the environmental impacts generated by an offshore wind power plant during its lifetime.

Lifetime

The lifetime of the total wind power plant will have a proportional impact on the result. In the figure below a 30-year lifetime has been calculated for offshore turbines as the offshore wind turbines can technically operate up to 30 years. Wear of offshore turbines is less significant than for onshore turbines. Aspects regarding operation, i.e. servicing, are not taken into account in this calculation as it is assumed that these are insignificant.

Comparison of environmental impacts in relation to the lifetime of an offshore wind farm

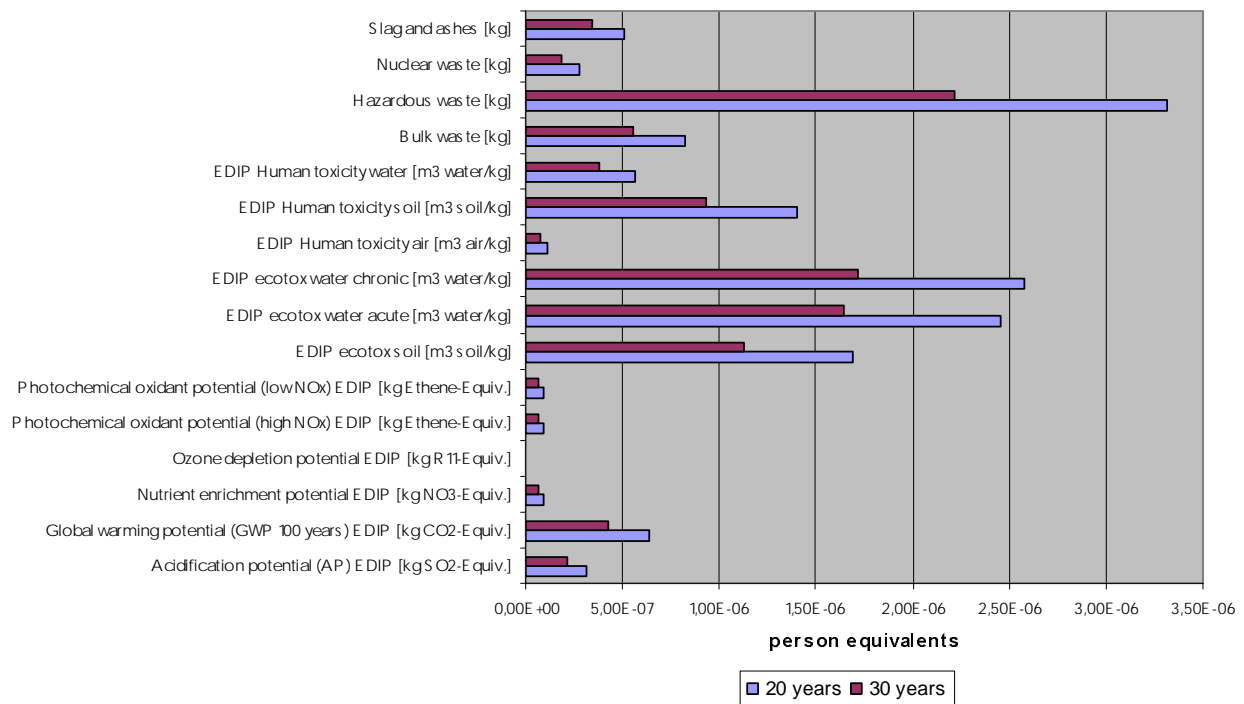

Figure 19: The lifetime's influence on environmental impacts.

The figure above shows that the total lifetime of the wind power plant is decisive for the environmental impacts of 1 kWh electricity generated from the wind power plant. The figure also shows that the lifetime is just as important as the production of the wind power plants as both result in direct linear changes of the environmental impacts, calculated per kWh generated by the wind power plants. At a lifetime of thirty years for the offshore turbines the environmental impacts are decreased by approximately 30% compared with the 20-year lifetime of the turbines.

It should, however, be noted that wind power plants occupy areas which cannot be used for other purposes. This means that if the wind power plant continues to operate for 30 years the wind power plant will occupy potential attractive space for a longer period, which could have been used for other purposes.

Recycling

The selected scenario for recycling of materials has proved to be important for the total environmental impacts as it has been found that the used materials are decisive for the environment profile regarding electricity generated by wind power plants. Without the reutilisation scenario, the environmental impacts would be significantly higher.

As large quantities of metals are used for wind power plants, and especially for offshore wind power plants, due to the steel foundations and a large transmission grid, a sensitivity analysis has been prepared regarding the recycling of metals used for offshore wind power plants.

At the workshop where dismantling and disposal of turbines was discussed, the actual recycling scenario was discussed and it was observed that many metals could have a higher recycling rate than

90% if the materials were separated. Therefore, in this case we have made calculations based on the assumption that total separation of materials is carried out and that the recycling rate of metals is 100%.

The following scenarios for recycling of metals have been estimated:

- The actual scenario, as described in table 2
- 100% recycling of metals

Comparison of environmental impacts in relation to the recycling percentage of metals

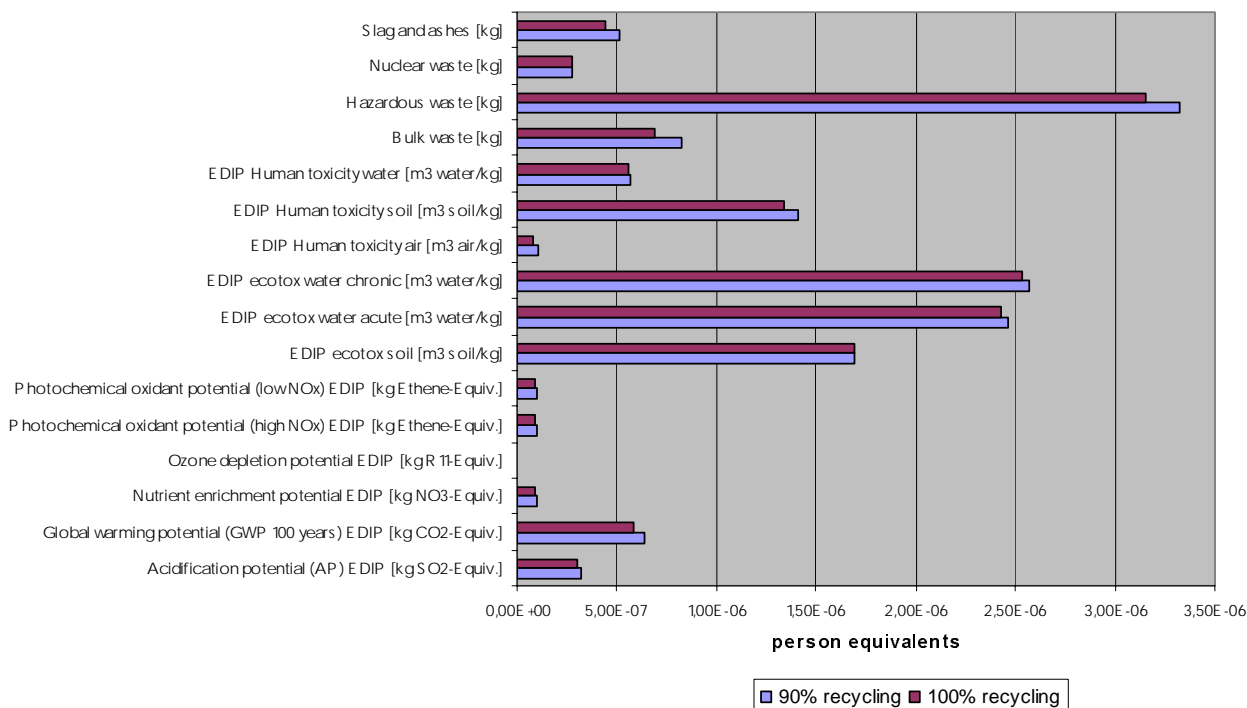

Figure 20: The total environmental profile for the V90-3.0 MW offshore wind power plant with various recycling scenarios for metals.

The above figure shows that recycling of metals is very important for the total environmental profile regarding 1 kWh electricity generated by the offshore wind power plant. I.e. a 10% increase in recycling results in a reduction of global warming of approximately 8%.

Shortcomings

Basically, all incoming substances and materials for the turbines and transmissions have been included in present LCA. However, since it has been difficult to obtain LCA data on several substances, it has been necessary to make certain assumptions. This applies to glue and electronic components, among other things. For each of these materials we have been made assumptions and simplifications as described in the chapter "Procedures for data collection". Vestas will continue to focus on collecting data from the entire life cycle based on the significance of the data.

Sub-suppliers' energy consumption has not been stated in all cases. For the majority of the materials used (steel, glass fibre, rubber and plastics) assumptions of energy for processing have been made. A sensitivity analysis on data for processing of steel (see chapter "Sensitivity analysis") has proved that energy consumption for processing steel has an impact on hazardous waste. This can, however, be explained by the fact that steel consumption for the wind power plant is high. Regarding Prepreg, carbon fibre and glass fibre consumption is not significant and it is expected that processing does not have great impact on the energy balance. Furthermore, a sensitivity analysis has been made for the processing of copper components in the transmission of the offshore wind power plant. As seen in table 4 copper consumption is most significant in the transmission of the offshore wind power plant. It was, however, proven that the processing of copper does not have a significant influence on total environmental impacts. On that basis it has been estimated that the lack of data has less impact on the total assessment.

Conclusions

In this project an LCA has been prepared for a V90-3.0 MW offshore wind power plant and a V90-3.0 MW onshore wind power plant respectively, including grid connection. This LCA model for wind power plants has been improved compared to the previous LCA of the V80-2.0 MW turbine.

This life cycle assessment has shown that environmental impacts per kWh electricity generated by the two wind power plants are close to being identical within the expected uncertainties of the results. Resource consumption by the offshore wind power plant is significantly higher than for the onshore wind power plant. However, increased electricity generation by the offshore wind turbines outweighs the increased resource consumption. If environmental impacts from wind turbines are compared to average European electricity generation, then the environmental impacts for wind turbines are hardly noticeable.

Furthermore, the result of product development processes can be seen as the V90-3.0 MW environmental profile has improved in relation to the V80-2.0 MW turbine. I.e. the energy balance for a V80-2.0 MW offshore turbine is 9.0 months whereas the energy balance for a V90-3.0 MW offshore turbine is 6.8 months.

Offshore wind power plants are still new and data used for offshore wind power plants is based on actual experience. However, the data used indicates an above average site placement regarding the energy production of the wind power plant.

Electricity production in relation to resource consumption is seen as the most important aspect of both offshore and onshore wind power plants. I.e. a 50% increase of the electricity production will result in a 50% decrease of the energy balance. Furthermore, the disposal stage and especially the recycling of metals are also contributing to the environmental profile. Environmental impacts from the transport stage and the operation stage are not considered significant in relation to the total environmental impacts of both the offshore and onshore wind power plants.

Appendix 1

The following table shows normalized values for V90-3.0 MW offshore and onshore based wind power plants. Environmental impacts are stated in person equivalents (PE). The table reflect what 1 kWh power produced from the wind power plants through their lifetime make up of an average citizen's total impact.

	V90-3.0MW offshore	V90-3.0MW onshore
Acidification	3,17E-07	3.01E-07
Global warming	6,35E-07	5.68E-07
Nutrient enrichment	9,58E-08	8.26E-08
Ozone depletion	3,53E-09	2.00E-09
Photochemical oxidant (high NO _x)	9,53E-08	4.63E-08
Photochemical oxidant (low NO _x)	9,41E-08	4.47E-08
ecotox soil	1,69E-06	2.90E-06
ecotox water acute	2,46E-06	2.68E-07
ecotox water cronic	2,57E-06	3.26E-07
Human toxicity air	1,08E-07	7.94E-08
Human toxicity soil	1,41E-06	1.96E-06
Human toxicity water	5,64E-07	3.07E-07
Bulk waste	8,25E-07	7.90E-07
Hazardous waste	3,32E-06	4.54E-06
Nuclear waste	2,79E-07	2.83E-07
Slag and ashes	5,12E-07	4.52E-07

Appendix 2



Review comments

Life cycle assessment of offshore and onshore sited
wind power plants based on Vestas V90-3.0 MW

A review of the LCA on Vestas V90-3.0 MW wind turbines have been carried out by FORCE Technology.

Main responsible for the review has been:

Jeppe Frydendal

M.Sc. in Engineering

Head of LCA Center Denmark

FORCE Technology, Sustainability Management

Other experts have been involved in specific parts of the review process:

Anders Christian Schmidt

PhD

Senior Project Manager, R&D Coordinator LCA

FORCE Technology, Sustainability Management

Jan Poulsen

M.Sc. in Engineering

Project Manager

FORCE Technology, Sustainability Management

The review has been carried out according to ISO 14040:1997 as an external expert review.

The following procedure has been used:

- Reviewer gets access to the LCA report and database prepared by Vestas.
- A number of random checks are performed by FORCE Technology.
- Comments are forwarded to Vestas.
- Together with Vestas the reviewer goes more thoroughly into model structure and asks - further questions and ask for specific documentation following a random check procedure.
- Vestas implements changes in report and model based on review comments and own further quality assurance.
- Final report and database is sent to reviewer for the final review, where the review report is prepared.
- A summary of the conclusions of the review is prepared for the report.

Goal

Goal

The goal of the report is clearly defined:

- To document the environmental performance
- To be able to use the information for product development
- To improve previous LCAs on Vestas wind turbines

Use

The use of the LCA is stated as:

- To prepare an environmental product declaration
- To use the result for design
- To use for an assessment of the environmental characteristics of Vestas turbines

Target group

The target groups are defined as:

- Customers of Vestas
- Vestas Wind Systems A/S
- Investors of Vestas Wind Systems A/S
- Other stakeholders, including energy authorities from countries with interest in renewable energy that should be able to use the overall results as part of an assessment of the environmental characteristics of Vestas turbines.

As the target group is not very specific it is difficult to assess if the communication is suitable for the target group. However, based on the target group (even not well defined) an appropriate combination of simplicity and details have been used making the report readable for a broader range.

Recommendation: A more clear definition of the target group could be preferred. For example “Vestas Wind Systems A/S” is that the top managers, the designers, the blue-collar worker? The LCA has one target group whereas the environmental product declaration have another and probably broader audience.

Scope

Functional unit

The functional unit is defined as:

1 kWh electricity produced at respectively onshore and offshore wind power plants with V90-3.0MW turbines.

This is measurable and can be related to similar functional units. As an extra service the reader is reminded that when comparing this is not equivalent to electricity delivered to the consumer. When comparing with 1 kWh European electricity in the report, this has been taken into account.

Recommendation: To include the geographical area in the functional unit to or in relation to this to answer the question: Where are the results valid? Only for site placement in Denmark or in Europe or an average for the world?

System boundaries

All relevant stages of the life cycle seem to be included. And the impression you get is that most materials and processes have been included. The completeness of data is much better than in the previous LCA reports and models on the V80-2.0 MW turbine.

Comparing this study with other studies of electricity generation this study is probably one of the most complete.

In some cases the manufacturing of intermediate products has been excluded and there has been no argumentation showing the relevance of that. For example the external cables are only included as materials. Relatively easy it would probably have been possible to find data for a good assumption. Green accounts for NKT cables or similar could have given some good estimates.

Recommendation: To go through the report and model to find out the remaining data gaps and find easy assessable data to close the gaps.

Included data categories and impacts

The impact categories from the EDIP methodology have been chosen. This is acceptable in comparison of the goal.

Recommendation: To look into the data categories of EPD-schemes on electricity production and make sure that the selected categories are comparable.

Data quality requirements

The data quality requirements are stated and fits the main needs. For the most important materials a requirement to use data that are in range with other comparable data for the same materials could have been included. However, this can be difficult for the LCA practitioner to make sure if he/she does not have access to a lot of data sources. Therefore, the review has focused on this when making random checks.

Recommendation: For the most important raw materials to use data that lies within the range of what is internationally accepted. Of course, this should be a job for the database provider to ensure, but this is typically not the case.

System expansion and allocation

Wind turbines do only produce electricity so concerning the main production allocation or system expansion is not needed. However, in the recycling it has been chosen to use system expansion and include avoided production of the recycled materials that are prepared to be used as secondary materials. This is in accordance with common recommendations.

For some products and materials used in the life cycle the allocation principles are not transparent, typically because this is not stated in the database documentation. An example is European electricity 1990. For many technologies also thermal energy for district heating is produced. How an allocation is made between these products are made could have an impact on the comparison, but not enough to impact the overall results.

Chosen methodology

The Danish EDIP methodology has been chosen, but only characterization and normalization steps are carried out. Weighing is as such not performed.

This methodology (version 1997 00/94) is internationally accepted and the official Danish methodology.

Description of the critical review process

The critical review process is only briefly described in the LCA report and this report is not included. This, of course, does not influence the results, but it might affect the readers' impression of the credibility.

Inventory

Description of data

No single datasets are presented in the report, but only in the underlying LCA model. Some data are only described in the old LCA report and not very well.

In the results section aggregated datasets are presented with reference units.

In the model and in the report there is no clear indication of where the data quality requirements are fulfilled and where they are not.

The LCA report states for which processes data have been used and which type of data – generic from databases, assumptions based on ... etc.

Recommendation: To describe the data quality parameters in the report – for example by using appendices. In this way it will still be possible to have a relatively easy readable report even though the important information of data quality is included.

Distribute the data via official databases if you want your data to be used. LCA Center Denmark could be a starting point.

Verification of data

Where data are missing the general tendency is that an assumption is made instead of excluding data. Often a conservative estimate is chosen.

In the critical review random checks of mass balances was performed and in a few cases some errors were corrected.

Furthermore, the review looked into some of the data used for specific materials:

Glass fibre	Glass fiber EDIP	Comparing energy and GWP with data from the GaBi extension database shows that compared to this the used data represents low impacts. About half energy per kg and 3-4 times less GWP. However, the importance of glass fiber in the study is low and nobody knows which data are the best for the used fibers at Vestas..
Steel	Steel, cold rolled plate (89% primary), Aggregated	Comparing the same factors with data from the GaBi ekstension database of cold rolled steelplates from Germany (2.5 mm), they don't differ that much. However, the German data looks to have less impacts than the used data from the EDIP database. Steel is important, and the data used can probably be seen as a conservative estimate.
Copper	Copper, 82 % primary, Aggregated	Comparing energy and GWP with 4 different dataset from other data providers shows that the used data lies within the range. Data varies in energy 69MJ-119MJ (used data = 83MJ) per kg. GWP from 1,72 kg CO2-eq. to 7,51 kg CO2-eq. Used data: 5,67 kg CO2-eq.

Aluminium	Al (primary) I, Aggregated	<p>This has been compared with data on Aluminium ingot from PE Europe and does not differ significantly on the compared parameters.</p> <p>However, it seems that processing of the aluminium from ingot to aluminium products included in the wind power plants is excluded in the model. It of course does cost some more energy with emissions etc.</p> <p>A die-cast process for aluminum uses around 5 MJ electricity or about 15 MJ/kg of primary energy.</p>
-----------	----------------------------	---

Recommendation: To include the mass in Vestas own flows, which would make it much easier to make quality assurance. Hence, more quality control could be performed within the same time frame.

Use of data compared to the goal

It is not possible for the reader to determine the level of detail of the data used in the study, as this is not described.

However, it is described if data does not cover all locations where the actual production takes place. For example data from Vestas' own production has been used as being representative for similar production at sub-suppliers.

Recommendation: To include a qualitative description of the used data to show whether the data fulfils the data quality requirements – and to describe the level of detail of the data from Vestas' own data collection. A further improvement could, of course, be to collect more data from sub-suppliers, but it is probably not as important as to get good data quality for material production.

Aggregation of data

The data aggregation has been performed in the GaBi tool, which reduces the risk of errors. Spot checks of parts of the calculations did not reveal any errors.

Documentation of system boundaries, system expansions and allocation

For the processes and parts of the system where Vestas has modeled data and the system, the principles of system allocation are presented. However, for aggregated data from the databases it is not described in the report – and often the databases have a poor documentation of this.

It is difficult to see how this could be improved with the generic data available today. In the future there will probably be a common international set of data documentation requirements, where descriptions like this will be included.

Interpretation and limitations of selected system boundaries

Compared to other modeling of electricity productions and compared to the previous report on wind turbines, this study includes larger parts of the system. The chosen system boundaries seem fair.

In the comparison with 1 kWh of European average electricity it is not possible to compare the system boundaries of the two systems and therefore a comparison can not directly be made.

However, to show the order of magnitude is important to interpret the results. Furthermore, the modeling of European electricity most probably excludes larger parts of the systems than the Vestas V90-3.0 MW wind turbines.

A problem is, of course, that it is 1990 electricity compared to 2005-2025 electricity, but the problem is that the more recent electricity data in the EDIP database has been proven at the moment to be erroneous.

If someone wants to compare energy balances of different renewable technologies they should be sure that the system boundaries are similar. The energy extracted from the wind at the wind power plant is not included in the Vestas data.

Evaluation

Evaluation of characterization and characterization factors

Vestas has chosen to use the EDIP methodology, which is also the recommendation from the Danish EPA and an internationally accepted methodology.

Before the calculations Vestas received the most recent updated characterization factors from the Danish LCA Center.

Evaluation of normalization

The report only presents normalized results with no weighting. The calculations were spot-checked and we found out that the calculation performed without weighting. This has been corrected in the final report.

The EDIP 1997 methodology with reference year 1990 has been used. This is what is recommended at the moment. Within the next year or so the recently published normalization references for 1994 will be integrated into the GaBi tool. After this a new and more updated calculation can be performed.

Interpretation of results

Impact categories and sources

All important life cycle stages are included in the model, and it seems that also all materials and processes of importance are included. However, some important possible impacts are not included in the chosen methodology and hence, not described at all. Considering wind turbines there has in the media been focus on impacts like:

- Noise,
- physical impacts on birds, and
- use of land area

Recommendation: To describe the above-mentioned impacts qualitatively.

Completeness, sensitivity and consistency

A comprehensive sensitivity analysis has been performed to show the importance of major assumptions. The assumptions are overall consistent with the goal and scope of the study.

Evaluation of limitations in the conclusion

The conclusion is in accordance with the modeling and results.

Compliance with ISO 14040:1997 – ISO 14043:1997

Vestas can't claim that they follow the ISO standards, even though that they for most of their work do. However:

- The report in the end compares 1 kWh of Vestas electricity with 1 kWh of EU average electricity. This is important to relate the results to something with the same functional unit to get an idea of the order of magnitudes, but can also be seen as a “comparative assertion” which requires a review by interested parties. This is a matter of interpretation of the standard – both in relation to what a comparative assertion is, but also what the definition of review by interested parties. The standard says that it is a panel that may include other interested parties.

Conclusion

Force Technology has conducted a critical review of the LCA model and the documentation and a number of random checks have been made. The review has not found anything, which in overall terms can influence the final result of the assessment. The LCA model is significantly improved and enhanced compared with the previous LCA reports and models of the V80-2.0 MW. Furthermore, areas have been proposed where model and underlying data can be improved for the next LCA project.

References

-
- i Life cycle assessment of turbines PSO 1999. Elsam Engineering A/S 2001.
 - ii Life cycle assessment of onshore and offshore sites wind power plants. Elsam Engineering A/S 2004.
 - iii Based on information from “Life cycle assessment of onshore and offshore sites wind power plants. Elsam Engineering A/S 2004”.
 - iv Summary of Vattenfall AB’s Certified Environmental Product Declaration of Electricity from the Nuclear Power Plant at Ringhals, Vattenfall AB, 2002-02-15
 - v The Plastic industry’s homepage: http://www.plast.dk/public_html/070mil.htm
 - vi Working Report from Danish Environmental Protection Agency No. 16 2001 ‘Explanation about the environmental declaration of consumer electronics – from knowledge to action’. Prepared by Heidi K. Stranddorf, Jakob Zeuten and Leif Hoffmann dk-TEKNIK Energy & Environment.
 - vii Environmental Statement 1999, Aalborg Portland.
 - viii Ebbe Rislund, Corrosion expert at FORCE Technology A/S
 - ix Environmental design of industrial products. EDIP. Henrik Wenzel, Michael Hauschild and Leo Alting. Technical University of Denmark; The Danish Ministry of Environment, Danish Environmental Protection Agency; Danish Confederation of Industries. 1997.